



GPC2000 SERIES PARTS MANUAL



Order Number: 812720-006
Revision: A • Printed in Germany

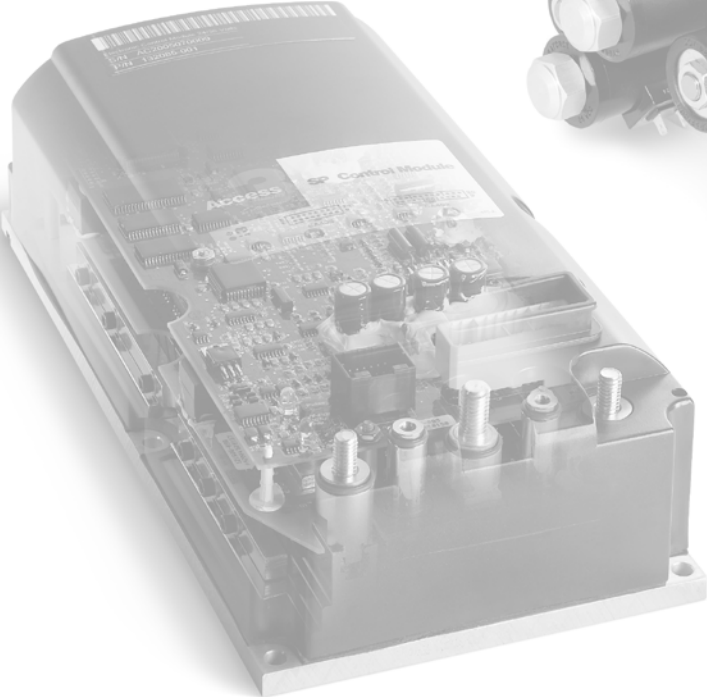
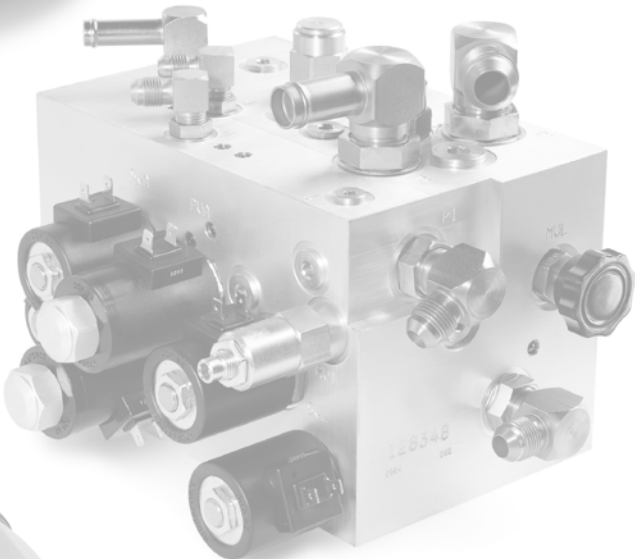

TABLE OF CONTENTS





TABLE OF CONTENTS

TABLE OF CONTENTS

INTRODUCTION	PAGE	REV.
Important customer information	3	
Subsequent Attachments and Modifications made to the Truck	3	
Ordering Spare Parts	3	
Using the Manual	3	
Models	4	
COVERS	PAGE	REV.
Covers Part 1 - 2 Up to ser. no. 5A400139	6	02 Rev. 01/01
Covers Part 1 - 2 Up to ser. no. 5A400139	8	02 Rev. 01/01
Covers Part 1 - 2 From ser. no. 5A400140	10	
Covers Part 1 - 2 From ser. no. 5A400140	12	
Covers Part 2 - 2	14	03 Rev. 03/07
Castor Wheel up to 12/2000	16	02 Rev. 01/01
Castor Wheel from 01/2001	18	
Load Wheel	20	02 Rev. 03/07
Wheels GPC Tow	22	
HYDRAULIC SYSTEM	PAGE	REV.
Tube/Hose Layout Up to ser. no. 5A400698	26	02 Rev. 01/01
Tube/Hose Layout From ser. no. 5A400699	28	
Tube/Hose Layout Up to ser. no. 5A400698	30	01 Rev. 01/01
Tube/Hose Layout From ser. no. 5A400699	32	
Tube/Hose Layout Up to ser. no. 5A400698	34	01 Rev. 01/01
Tube/Hose Layout From ser. no. 5A400699	36	
Tube/Hose Layout Up to ser. no. 5A400698	38	01 Rev. 01/01
Tube/Hose Layout From ser. no. 5A400699	40	
Pump Motor and Pump Up to ser. no. 5A400698	42	03 Rev. 03/07
Pump Motor and Pump Up to ser. no. 5A400698	44	03 Rev. 03/07
Pump Motor and Pump From ser. no. 5A400699	46	
DRIVE UNIT	PAGE	REV.
Drive Unit	50	02 Rev. 01/01
Gearbox GPC2020	52	01 Rev. 01/01
Gearbox GPC2020	54	01 Rev. 01/01
Gearbox GPC2040/GPC2040S/GPC Tow	56	01 Rev. 01/01
Gearbox GPC2040/GPC2040S/GPC Tow	58	01 Rev. 01/01
Drive Motor GPC2020	60	02 Rev. 01/01
Drive Motor GPC2040/GPC2040S/GPC Tow	62	04 Rev. 03/07
Knuckle GPC2020	64	03 Rev. 03/07
Knuckle GPC2040/GPC2040S	66	02 Rev. 01/01
Knuckle GPC2040/GPC2040S	68	02 Rev. 01/01
Knuckle GPC Tow	70	
ELECTRICAL SYSTEM	PAGE	REV.
Electrical Parts	74	
Contactor Panel GPC2020 Part 1 - 2	76	03 Rev. 03/07
Contactor Panel GPC2020 Part 2 - 2	78	
Contactor Panel GPC2040/GPC2040S/GPC Tow Part 1 - 3 ..	80	02 Rev. 01/01
Contactor Panel 2040/2040S Part 2-3 Up to ser. no. 5A400698	82	

TABLE OF CONTENTS



Contactor Panel 2040/2040S Part 2-3 From ser. no. 5A400699	84	
Contactor Panel GPC Tow Part 3 - 3	86	
Steering Controller GPC2040S Up to ser. no. 5A401292	88	01 Rev. 03/07
Steering Controller GPC2040S From ser. no. 5A401293	90	
Drive Board Up to ser. no. 5A400698	92	03 Rev. 03/07
Drive Board Up to ser. no. 5A400698	94	
Traction Contactor GPC2020	96	
Traction Contactor GPC2040/GPC2040S/GPC Tow	98	
Pump Contactor From ser. no. 5A400699	100	
Walk Along GPC2040S	102	
Accelerator Switch GPC2040S	104	
Lift/Lower and Horn GPC2040S	106	
Control Handle Part 1 - 3	108	03 Rev. 03/07
Control Handle Part 2 - 3	110	
Control Handle Part 3 - 3	112	01 Rev. 03/07
Foot Brake and Walk Along GPC2020/GPC2040	114	02 Rev. 03/07
Walk Along and Lift/Lower GPC2040S	116	01 Rev. 03/07
Platform Lift and Fork Lift	118	01 Rev. 03/07
Battery Connector / Emergency Disconnect	120	03 Rev. 03/07
Dash Board	122	03 Rev. 03/07
Steering Indicator GPC2040S	124	
BRAKE SYSTEM	PAGE	REV.
Brake GPC2020	128	
Brake GPC2040/GPC2040S/GPC Tow	130	
STEERING	PAGE	REV.
Steering GPC2040S Part 1 - 2	134	01 Rev. 03/07
Steering Motor GPC2040S Part 2 - 2	136	01 Rev. 03/07
Steering GPC2040S Part 1 - 2	138	
Steering GPC2040S Part 2 - 2	140	
Steering Column GPC2020/GPC2040/GPC2040S	142	02 Rev. 01/01
Steering Column GPC Tow	144	
LIFTING MECHANISM	PAGE	REV.
Platform Lift	148	02 Rev. 03/07
Fork Lift	150	01 Rev. 03/07
Fork Carriage	152	01 Rev. 01/01
Lift Structure Part 1 - 2	154	03 Rev. 03/07
Lift Structure Part 2 - 2	156	01 Rev. 02/97
Load Backrest GPC2020/GPC2040/GPC204S	158	01 Rev. 01/01
Load Backrest Platform Lift	160	01 Rev. 01/01
Load Backrest Platform and Fork Lift	162	01 Rev. 01/01
Guard Rail GPC2040/GPC2040S	164	02 Rev. 03/07
CYLINDERS	PAGE	REV.
Lift Cylinder GPC2020/GPC2040/GPC2040S Part 1 - 2	168	
Lift Cylinder GPC2020/GPC2040/GPC2040S Part 2 - 2	170	
Lift Cylinder Platform	172	
Lift Cylinder Fork Lift	174	



TABLE OF CONTENTS

PLATFORM	PAGE	REV.
Platform GPC2020/GPC2040/GPC2040S/GPC Tow	178	02 Rev. 01/01
Platform GPC2020	180	02 Rev. 01/01
Platform GPC2040/GPC2040S/GPC Tow	182	03 Rev. 03/07
Platform Platform Lift	184	01 Rev. 03/07
Platform Fork Lift	186	01 Rev. 03/07

MISCELLANEOUS	PAGE	REV.
Hitch GPC Tow	190	
Labels and Decals Part 1 - 2	192	03 Rev. 03/07
Labels and Decals Part 2 - 2	194	

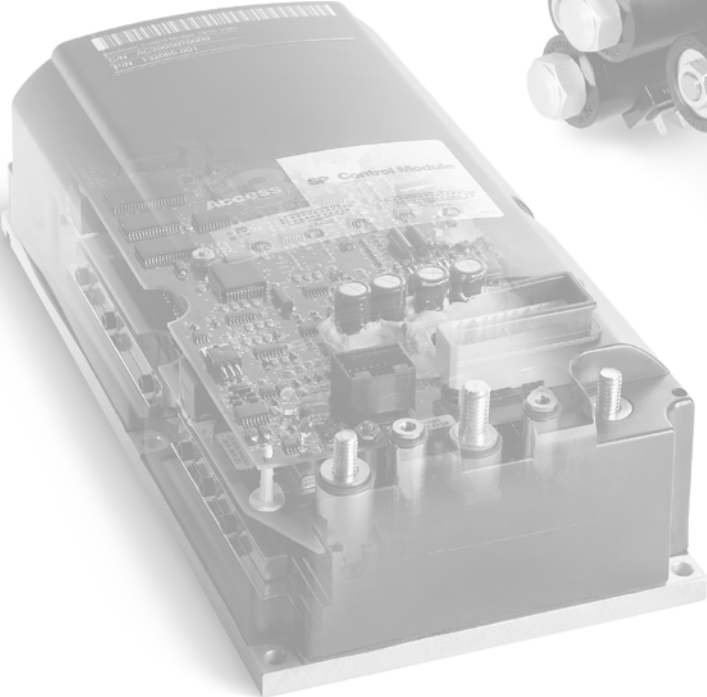
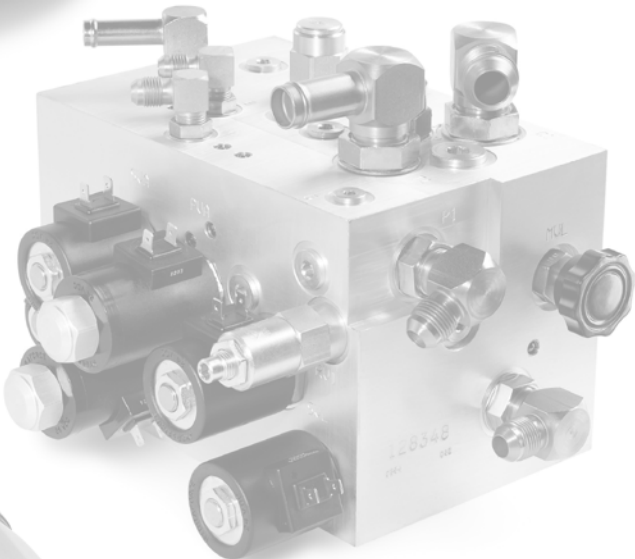

INTRODUCTION

Important customer information

To ensure the safety of the truck, you, the customer, must only carry out maintenance and repairs as stipulated in the operator manual.

Any additional work must be performed by Crown authorised service technicians. Authorised service technicians have the required expertise and up-to-date service information.

If you wish to have your own technicians trained, please contact Crown for relevant training courses.

Subsequent Attachments and Modifications made to the Truck



DANGER

Any proposed modification which would alter the original condition of the truck when delivered, must first be assessed and approved in writing by Crown Gabelstapler GmbH.

- *The net weight and position of attachments may considerably affect the capacity and other truck characteristics.*
- *Changing the electrical system or adding electrically operated components may result in operating faults.*

Modifications which have not been assessed may result in fatal accidents!

Ordering Spare Parts

The maintenance manual does not cover spare parts. These are listed in a separate parts manual.

Spare parts can be ordered by quoting:

- The truck specification number
- The truck model number

The truck serial number This information can be found on the truck's data plate. Only if this information is provided can the order be processed quickly, correctly and reliably.

Please refer to the Technical Specifications Sheet for the utilisable loads, technical data and dimensions for

this series. Brochures can be obtained from your CROWN dealer or from the following address:

CROWN Gabelstapler GmbH & Co.KG
Moosacher Str. 52
80809 Munich
GERMANY

Tel.: +49 (0)89 / 93 002 -0
Fax: +49 (0)89 / 93 002 -175 or133

Using the Manual

The manual is divided into chapters. The following table shows how the manual is structured.

Manual Structure	
Chapter	Content
ITD	Introduction
1	Covers
2	Hydraulic System
3	Drive Unit
4	Electrical System
5	Brake System
6	Steering
7	Lifting Mechanism
8	Cylinders
9	Platform
10	Miscellaneous

INTRODUCTION

Models



Models

Describes the following models:

GPC2020: Low Level Order Picker, 1.600 kg capacity

GPC2040: Low Level Order Picker, 2.000 kg capacity

GPC2040S: Low Level Order Picker with Steering Wheel, 2.000 kg capacity

GPC Tow: Tow Tractor

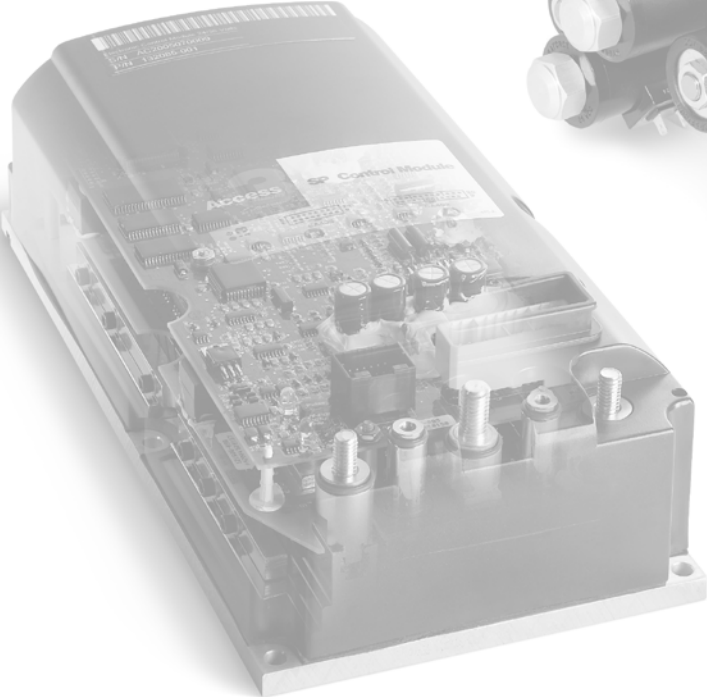
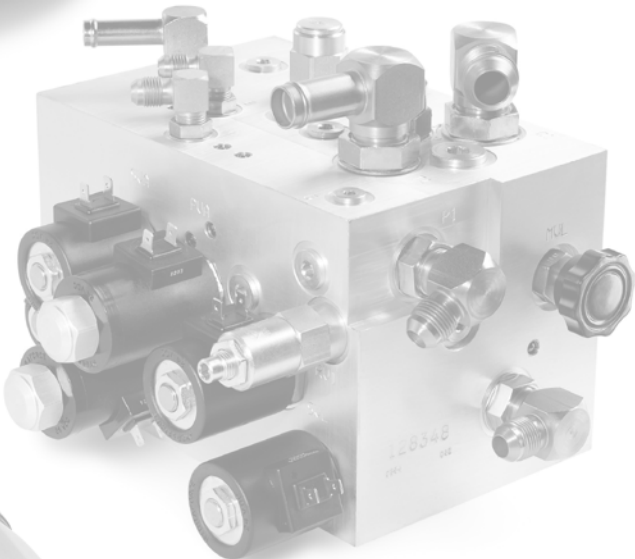

COVERS





COVERS

Covers Part 1 - 2 Up to ser. no. 5A400139

INDEX	PART NUMBER	PART NAME	NUMBER REQUIRED
1	804217-002-02	Cover (GPC2020)	1
	804217-002-01	Cover (GPC2040)	1
	055055-003	Edge Protection	1
2	804217-001-02	Cover (GPC2020)	1
	804217-001-01	Cover (GPC2040)	1
	055055-003	Edge Protection	1
3	804862	Buffer	4
4	805318	Clip	2
5	050008-008	Nut	4
	050009-012	Washer	4
6	804338	Battery Lock	2
7	050007-035	Screw	2
8	050008-034	Nut	2
9	804952	Holder (GPC2040)	1
10	804951	Holder (GPC2020)	1
11	050068-003	Nut	2
	050025-009	Screw	2
12	804652	Mushroom	1
13	051057-006	Spring	1
14	050009-025	Washer	1
15	050008-030	Nut	1
16	804277	Arbor	2
	050000-009	Pin	2
17	804207	Roller	6
18	804681	Bearing Ball	12
19	804208	Axle	6
20	804432	Battery Connector Anderson (assembly/included 21 & 22)	1
	061002-003	Clamp Anderson (GPC2020)	2
	050009-004	Washer Anderson (GPC2020)	1
	050008-001	Nut Anderson (GPC2020)	1
	803673	Battery Connector (Anderson)	1
	803649	Battery Connector Schaltbau (assembly/included 21 & 22)	1
	803546-001	Battery Connector (Schaltbau)	1
21	052050-023	Power Cable (B+/Anderson)	1
	052050-081	Power Cable (B+/Schaltbau)	1
	801988-004	Hose Guard (Schaltbau)	1
22	052050-022	Power Cable (B-/Anderson)	1
	052050-080	Power Cable (B-/Schaltbau)	1
	801988-004	Hose Guard (Schaltbau)	1
23	804303	Cover	1
	806506	Sheet	7
	050008-024	Nut	7
24	804863	Nut	2
25	050071-036	Screw	2
26	804862	Buffer	2
27	804423-001-01	Support (GPC2040)	1
	804423-001-02	Support (GPC2020)	1
	050068-003	Nut	2

Always Specify Model, Data & Serial Number

COVERS

Covers Part 1 - 2 Up to ser. no. 5A400139

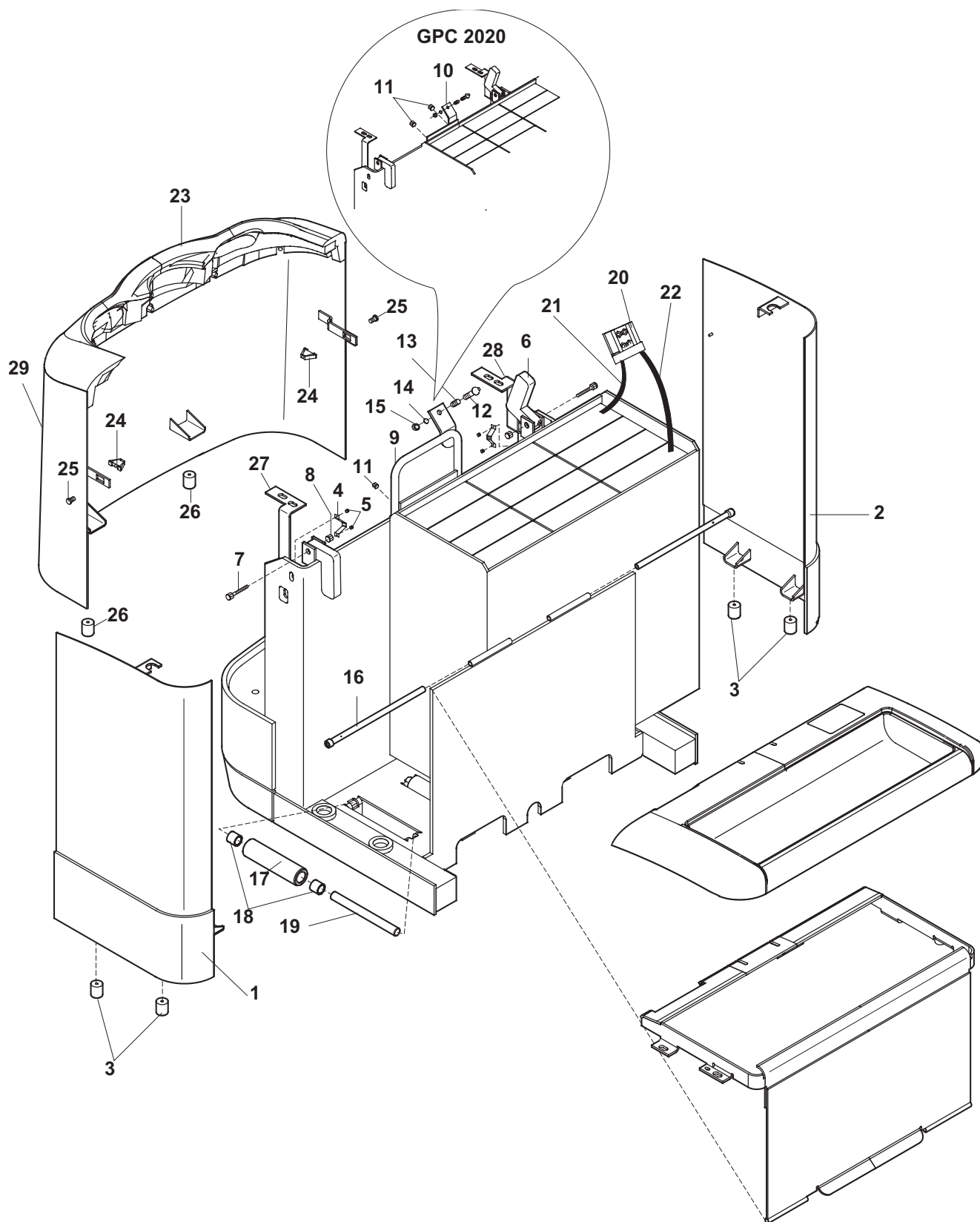

M0105



COVERS

Covers Part 1 - 2 Up to ser. no. 5A400139

INDEX	PART NUMBER	PART NAME	NUMBER REQUIRED
28	804423-002-01	Support (GPC2040)	1
	804423-002-02	Support (GPC2020)	1
	050068-003	Nut	2
29	804414-002	Cover (GPC2020)	1
	804414-001	Cover (GPC2040)	1
	804209-001	Batterierolle (inclusive 17 - 19)	6
	053002-001	Schmierfett	AR
	804209-002	Batterierolle (inclusive 17 - 19/Freezer/Corrosion)	6
	053002-005	Schmierfett (Freezer/Corrosion)	AR

not illustrated

810007	Support for Battery Roller (only for GPC2040S - 300 Ah)	1
810006-001	Load (only for GPC2040S - 300 Ah without Battery Roller)	1

* To select appropriate part number, refer to truck data number.
 The truck data number represents truck features.
 Refer to Introduction.

Always Specify Model, Data & Serial Number

BUY NOW

**Then Instant Download
the Complete Manual
Thank you very much!**