

SAFETY

RECOGNIZE SAFETY INFORMATION

- These are the **SAFETY ALERT SYMBOLS**.
 - When you see these symbols on your machine or in this manual, be alert to the potential for personal injury.
 - Follow recommended precautions and safe operating practices.

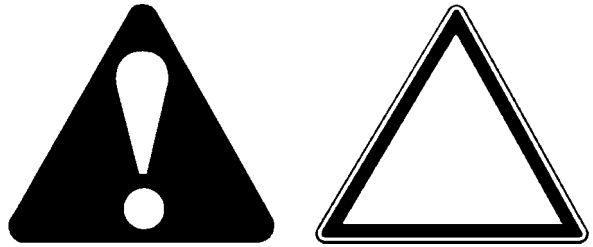

001-E01A-0688

SA-688

UNDERSTAND SIGNAL WORDS

- On machine safety signs, signal words designating the degree or level of hazard - **DANGER**, **WARNING**, or **CAUTION** - are used with the safety alert symbol.
 - **DANGER** indicates an imminently hazardous situation which, if not avoided, will result in death or serious injury.
 - **WARNING** indicates a potentially hazardous situation which, if not avoided, could result in death or serious injury.
 - **CAUTION** indicates a potentially hazardous situation which, if not avoided, may result in minor or moderate injury.
 - **DANGER** or **WARNING** safety signs are located near specific hazards. General precautions are listed on **CAUTION** safety signs.
 - Some safety signs don't use any of the designated signal words above after the safety alert symbol are occasionally used on this machine.



IMPORTANT



- **CAUTION** also calls attention to safety messages in this manual.
- To avoid confusing machine protection with personal safety messages, a signal word **IMPORTANT** indicates a situation which, if not avoided, could result in damage to the machine.
-  **NOTE** indicates an additional explanation for an element of information.

002-E01C-1223

SA-1223

SAFETY

FOLLOW SAFETY INSTRUCTIONS

- Carefully read and follow all safety signs on the machine and all safety messages in this manual.
- Safety signs should be installed, maintained and replaced when necessary.
 - If a safety sign or this manual is damaged or missing, order a replacement from your authorized dealer in the same way you order other replacement parts (be sure to state machine model and serial number when ordering).
- Learn how to operate the machine and its controls correctly and safely.
- Allow only trained, qualified, authorized personnel to operate the machine.
- Keep your machine in proper working condition.
 - Unauthorized modifications of the machine may impair its function and/or safety and affect machine life.
- The safety messages in this SAFETY chapter are intended to illustrate basic safety procedures of machines. However it is impossible for these safety messages to cover every hazardous situation you may encounter. If you have any questions, you should first consult your supervisor and/or your authorized dealer before operating or performing maintenance work on the machine.

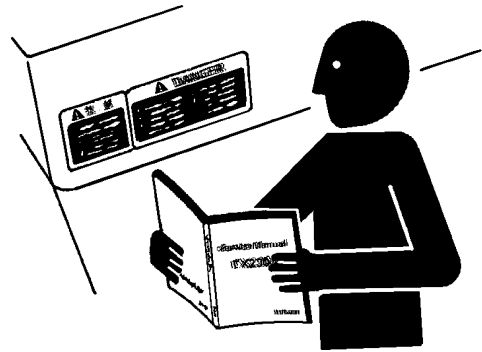

SA-003

003-E01C-0003

PREPARE FOR EMERGENCIES

- Be prepared if a fire starts or if an accident occurs.
 - Keep a first aid kit and fire extinguisher on hand.
 - Thoroughly read and understand the label attached on the fire extinguisher to use it properly.
 - Be sure to check and service the fire extinguisher at regular intervals following instructions in the fire extinguisher operation manual to maintain it in good operating condition.
- Establish emergency procedure guidelines to cope with fires and accidents.
- Keep emergency numbers for doctors, ambulance service, hospital, and fire department posted near your telephone.

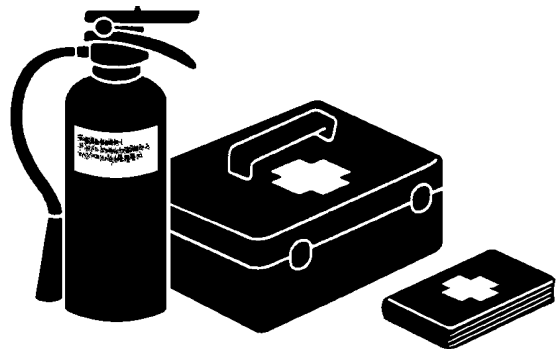

SA-437

004-E01B-0437

SAFETY

WEAR PROTECTIVE CLOTHING

- Wear close fitting clothing and safety equipment appropriate to the job.

You may need:

- A hard hat
- Safety shoes
- Safety glasses, goggles, or face shield
- Heavy gloves
- Hearing protection
- Reflective clothing
- Wet weather gear
- Respirator or filter mask.

Be sure to wear the correct equipment and clothing for the job. Do not take any chances.

- Avoid wearing loose clothing, jewelry, or other items that can catch on control levers or other parts of the machine.

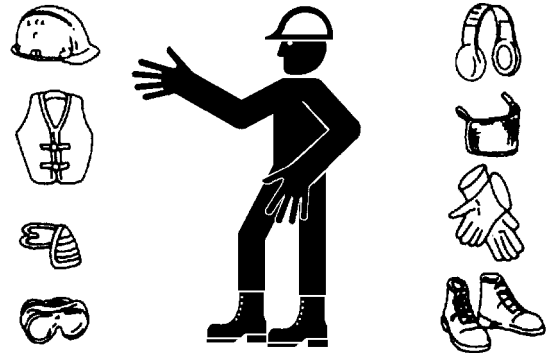

SA-438

005-E01B-0438

PROTECT AGAINST NOISE

- Prolonged exposure to loud noise can cause impairment or loss of hearing.
- Wear a suitable hearing protective device such as earmuffs or earplugs to protect against objectionable or uncomfortably loud noises.



006-E01A-0434

SA-434

INSPECT MACHINE

- Inspect your machine carefully each day or shift by walking around it before you start it to avoid personal injury.
- In the walk-around inspection be sure to cover all points described in the “PRE-START INSPECTION” chapter in the operator’s manual.



007-E01A-0435

SA-435

SAFETY

SAFETY OPERATOR'S STATION

- Clean mud or grease from your shoes before getting on the machine. Failure to do so may result in the possibility of your shoes slipping off the pedals, causing a safety hazard.
- Don't leave parts and/or tools lying around the operator's seat. Always store them in their proper place.
- Never attach any thing such as a window hanger close to the windowpane. Never place the bottle in the operator's station. They may cause a fire and impede visibility.
- Don't listen to music headphone or the radio, and don't use a cellular telephone in the operator's station while driving or operating the machine.
- Keep inflammable and/or explosive away from the operator's station.
- Be sure to put a cover on the ashtray to completely extinguish match and tobacco.
- Don't leave a lighter anywhere in the operator's station. The lighter may explode when temperature in the operator's station increases.

524-E01A-0000

SECTION AND GROUP CONTENTS

SECTION 1 GENERAL INFORMATION

Group 1 Precautions for disassembling and Assembling	
Group 2 Tightening Torque	

SECTION 2 UPPERSTRUCTURE

Group 1 Cab	
Group 2 Counterweight	
Group 3 Main Frame	
Group 4 Pump Device	
Group 5 Control Valve	
Group 6 Swing Device	
Group 7 Pilot Valve	
Group 8 Pilot Shut-Off Valve	
Group 9 Shockless Valve	

SECTION 3 UNDERCARRIAGE

Group 1 Swing Bearing	
Group 2 Travel Device	
Group 3 Center Joint	
Group 4 Track Adjuster	
Group 5 Front Idler	
Group 6 Upper and Lower Roller	
Group 7 Track	

SECTION 4 FRONT ATTACHMENT

Group 1 Front Attachment	
Group 2 Cylinder	

SECTION 5 ENGINE

TECHNICAL MANUAL (Operational Principle)

SECTION 1 GENERAL

- Group 1 Specification
- Group 2 Component Layout

SECTION 2 SYSTEM

- Group 1 Control System
- Group 2 Hydraulic System
- Group 3 Electrical System

SECTION 3 COMPONENT OPERATION

- Group 1 Pump Device
- Group 2 Swing Device
- Group 3 Control Valve
- Group 4 Pilot Valve
- Group 5 Travel Device
- Group 6 Others(Upperstructure)
- Group 7 Others(Undercarriage)

TECHNICAL MANUAL (Troubleshooting)

SECTION 4 OPERATIONAL PERFORMANCE TEST

- Group 1 Introduction
- Group 2 Engine Test
- Group 3 Excavator Test
- Group 4 Hydraulic Component Test
- Group 5 Standard

SECTION 5 TROUBLESHOOTING

- Group 1 Diagnosing Procedure
- Group 2 Component Layout
- Group 3 Troubleshooting A
- Group 4 Troubleshooting B
- Group 5 Troubleshooting C
- Group 6 Electrical System Inspection

WORKSHOP MANUAL

SECTION 1 GENERAL INFORMATION



CONTENTS

Group 1 Precautions for Disassembling and Assembling

Precautions for Disassembling and Assembling.....	W1-1-1
Maintenance Standard Terminology.....	W1-1-7

Group 2 Tightening Torque

Tightening Torque Specification.....	W1-2-1
Torque Chart	W1-2-3
Piping Joint	W1-2-6
Periodic Replacement of Parts	W1-2-10

GENERAL / Precautions for Disassembling and Assembling

PRECAUTIONS FOR DISASSEMBLING AND ASSEMBLING

Precautions for Disassembling and Assembling

- Clean the Machine

Thoroughly wash the machine before bringing it into the shop. Bringing a dirty machine into the shop may cause machine components to be contaminated during disassembling/assembly, resulting in damage to machine components, as well as decreased efficiency in service work.

- Inspect the Machine

Be sure to thoroughly understand all disassembling/assembly procedures beforehand, to help avoid incorrect disassembling of components as well as personal injury.

Check and record the items listed below to prevent problems from occurring in the future.

- The machine model, machine serial number, and hour meter reading.
- Reason for disassembly (symptoms, failed parts, and causes).
- Clogging of filters and oil, water or air leaks, if any.
- Capacities and condition of lubricants.
- Loose or damaged parts.

- Prepare and Clean Tools and Disassembly Area

Prepare the necessary tools to be used and the area for disassembling work.

- Precautions for Disassembling

- To prevent dirt from entering, cap or plug the removed pipes.
- Before disassembling, clean the exterior of the components and place on a work bench.
- Before disassembling, drain gear oil from the reduction gear.
- Be sure to provide appropriate containers for draining fluids.
- Use matching marks for easier reassembly.
- Be sure to use the specified special tools, when instructed.
- If a part or component cannot be removed after removing its securing nuts and bolts, do not attempt to remove it forcibly. Find the cause(s), then take the appropriate measures to remove it.
- Orderly arrange disassembled parts. Mark and tag them as necessary.
- Store common parts, such as bolts and nuts with reference to where they are to be used and in a manner that will prevent loss.
- Inspect the contact or sliding surfaces of disassembled parts for abnormal wear, sticking, or other damage.
- Measure and record the degree of wear and clearances.

GENERAL / Precautions for Disassembling and Assembling

- Precautions for Assembling

- Be sure to clean all parts and inspect them for any damage. If any damage is found, repair or replace part.
- Dirt or debris on the contact or sliding surfaces may shorten the service life of the machine. Take care not to contaminate any contact or sliding surfaces.
- Be sure to replace O-rings, backup rings, and oil seals with new ones once they are disassembled. Apply a film of grease before installing.
- Be sure that liquid-gasket-applied surfaces are clean and dry.
- If an anti-corrosive agent has been used on a new part, be sure to thoroughly clean the part to remove the agent.
- Utilize matching marks when assembling.
- Be sure to use the designated tools to assemble bearings, bushings and oil seals.
- Keep a record of the number of tools used for disassembly/assembly. After assembling is complete, count the number of tools, so as to make sure that no forgotten tools remain in the assembled machine.

Bleeding Air from Hydraulic System

When hydraulic oil is drained, the suction filter or the suction lines are replaced, or the removal and installation of the pump, swing motor, travel motor or cylinder is done, bleed air from the hydraulic system in the following procedures:

IMPORTANT: If the engine is started with air trapped in the hydraulic pump housing, damage to the pump may result. If the hydraulic motor is operated with air trapped in the hydraulic motor housing, damage to the motor may result. If the cylinder is operated with air trapped in the cylinder tube, damage to the cylinder may result. Be sure to bleed air before starting the engine.

- Bleeding Air from Hydraulic Pump

- Remove the air bleeding plug from the top of the pump and fill the pump housing with hydraulic oil.
- After the pump housing is filled with hydraulic oil, temporarily tighten the plug. Then, start the engine and run at slow idle speed.
- Slightly loosen the plug to bleed air from the pump housing until hydraulic oil oozes out.
- After bleeding all the air, securely tighten the plug.

- Bleeding Air from Travel Motor / Swing Motor

- With the drain plug / hose on travel motor / swing motor removed, fill the motor case with hydraulic oil.

GENERAL / Precautions for Disassembling and Assembling

- Bleeding Air from Hydraulic Circuit

- After refilling hydraulic oil, start the engine. While operating each cylinder, swing motor and travel motor evenly, operate the machine under light loads for 10 to 15 minutes. Slowly start each operation (never fully stroke the cylinders during initial operation stage). As the pilot oil circuit has an air bleed device, air trapped in the pilot oil circuit will be bled while performing the above operation for approx. 5 minutes.
- Reposition the front attachment to check hydraulic oil level.
- Stop the engine. Recheck hydraulic oil level. Replenish oil as necessary.

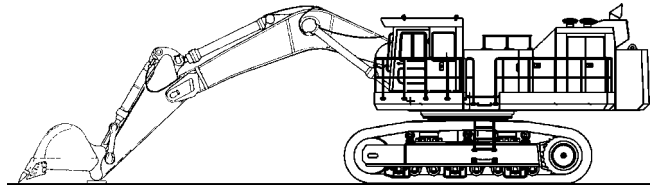

W183-04-02-003

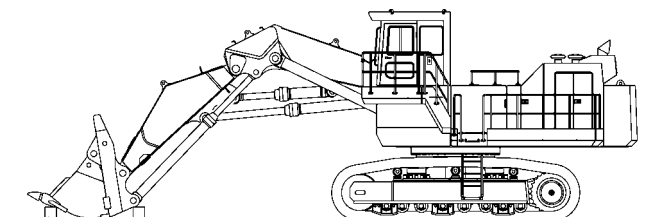

W183-04-02-002

枕木

GENERAL / Precautions for Disassembling and Assembling

Floating Seal Precautions

1. In general, replace the floating seal with a new one after disassembling. If the floating seal is to be reused, follow these procedures:

- (1) Keep seal rings together as a matched set with seal ring faces together. Insert a piece of cardboard to protect surfaces.
- (2) Check the slide surface on seal ring (A) for scuffing, scoring, corrosion, deformation or uneven wear.
- (3) Check O-ring (B) for tears, breaks, deformation or hardening.

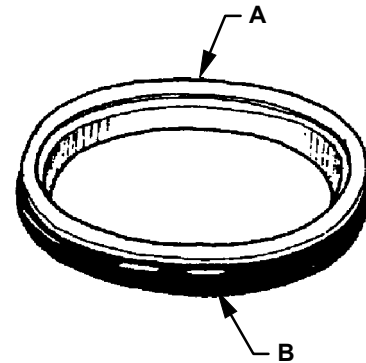

W105-03-05-019

2. If incorrectly assembled, oil leakage or damage will occur. Be sure to do the following, to prevent trouble.

- (1) Clean the floating seal and seal mounting bores with cleaning solvent. Use a wire brush to remove mud, rust or dirt. After cleaning, thoroughly dry parts with compressed air.
- (2) Clean the floating seal and seal mounting bores. Check the bore surface for scuffing or scoring by touching the surface with touch.
- (3) Check that the O-ring is not twisted, and that it is installed correctly on the seal ring.

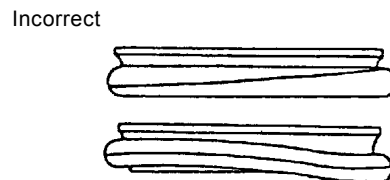
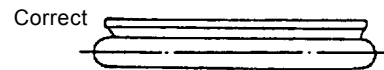
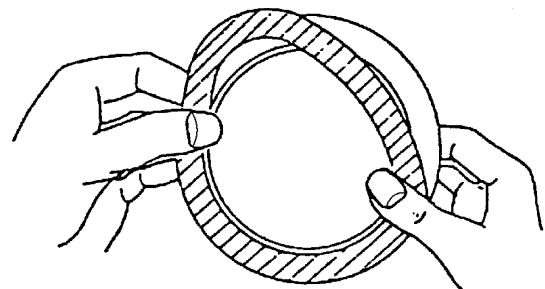

- (4) After installing the floating seal, check that seal ring surface (A) is parallel with seal mating face (C) by measuring the distances (A) and (C) at point (a) and (b), as illustrated. If these distances differ, correct the O-ring seating.

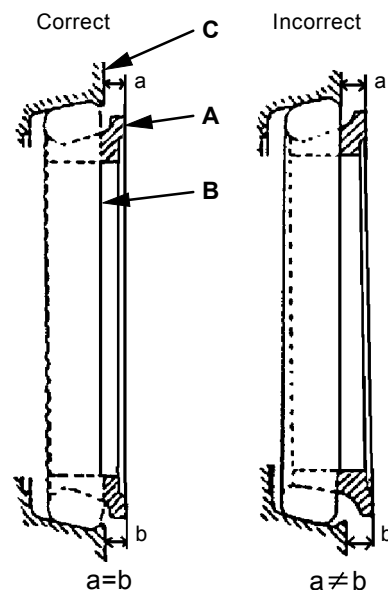

W105-03-05-020

W110-03-05-004

GENERAL / Precautions for Disassembling and Assembling

Precautions for Using Nylon Sling

1. Follow the precautions below to use nylon slings safely.
 - Attach protectors (soft material) on the corners of the load so that the nylon sling does not directly contact the corners. This will prevent the nylon sling from being damaged and the lifted load from slipping.
 - Lower the temperature of the lifted load to lower than 100 °C (212 °F). If unavoidably lifting a load with a temperature of 100 °C (212 °F) or more, reduce the load weight.
 - Do not lift acid or alkali chemicals.
 - Take care not to allow the sling to become wet. The load may slip.
 - When required to use more than one sling, use slings with the same width and length to keep the lifted load balanced.
 - When lifting a load using an eyehole, be sure to eliminate any gaps between the sling and load. (Refer to the right illustration.) Reduce the load weight so that it is less than 80 % of the sling breaking force.
 - Avoid using twisted, bound, connected, or hitched slings.
 - Do not place any object on twisted or bent slings. (Refer to the right illustration.)
 - When removing the slings from under the load, take care not to damage the nylon slings. Avoid contact with protrusions.
 - Avoid dragging slings on the ground, throwing slings or pushing slings with a metal object.
 - When using with other types of slings (wire rope) or accessories (shackle), protect the joint so that the nylon sling is not damaged.
 - Store the nylon slings indoors so they won't deteriorate with heat, sun light, or chemicals.

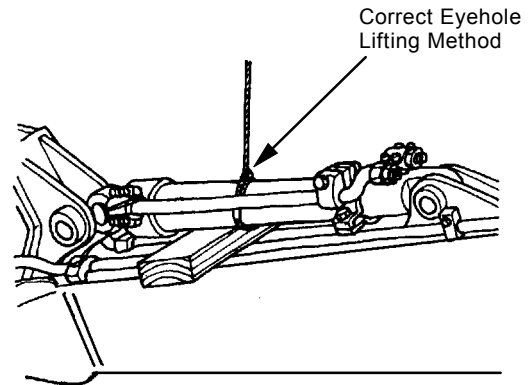

W102-04-02-016

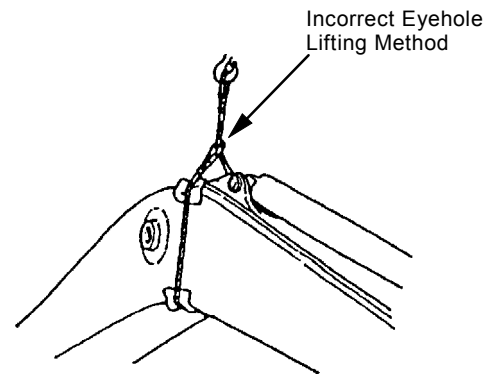

W105-04-01-008

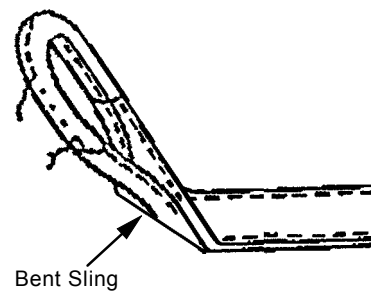

W162-01-01-009

GENERAL / Precautions for Disassembling and Assembling



CAUTION: If a load is lifted with a damaged nylon sling, serious personal injury may result. Be sure to visually check the nylon sling for any damage before using.

2. Before using a nylon sling, visually check the nylon sling for any damage corresponding to examples shown to the right. If any damage is found, cut and discard the sling. Even if no damage is found, do not use slings older than 7-years.

Damaged Appearance

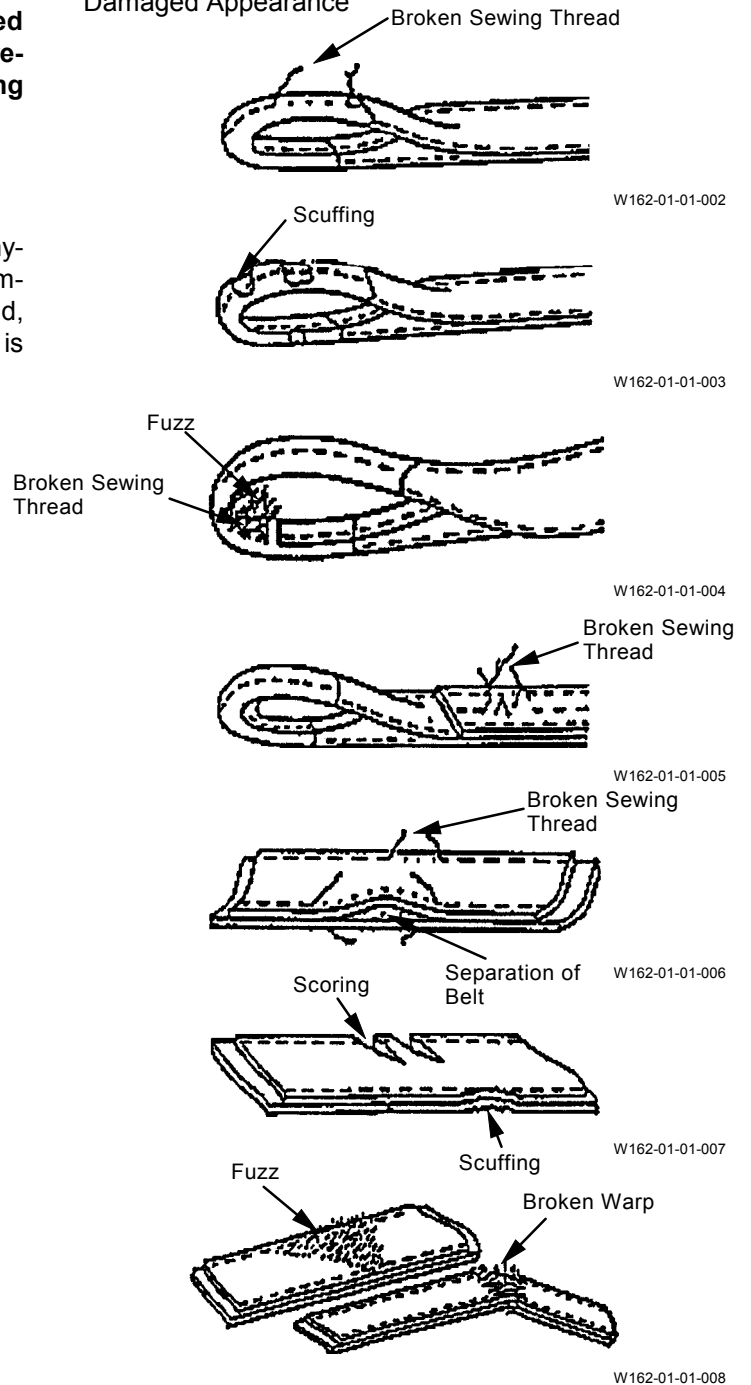

GENERAL / Precautions for Disassembling and Assembling

MAINTENANCE STANDARD TERMINOLOGY

“Standard”

1. Dimension for parts on a new machine.
2. Dimension of new components or assemblies adjusted to specification.

“Allowable Limit”

1. Normal machine performance cannot be accomplished after exceeding this limit.
2. Repair or adjustment is impossible after exceeding this limit.
3. Therefore, in consideration of operation efficiency and maintenance expense, proper maintenance shall be carried out before reaching the “Allowable Limit”.

GENERAL / Tightening

TIGHTENING TORQUE SPECIFICATIONS

Descriptions	Bolt Dia. (mm)	Q'ty	Wrench Size mm	Torque		
				N-m	(kgf.m)	(lbf.ft)
Engine cushion rubber mounting bolt(Fan side) (Pump side)	22	2	32	740	(75)	(540)
	33	2	50	2550	(260)	(1880)
Engine bracket mounting bolt	27	12	41	1030	(105)	(760)
Radiator mounting bolt	27	4	30	1030	(105)	(760)
Hydraulic oil tank mounting bolt	20	8	30	540	(55)	(400)
Fuel tank mounting bolt	20	8	41	540	(55)	(400)
ORS fittings for hydraulic hoses and piping	1-7/16- 12UNF	4	41	205	(21)	(152)
	1-11/16- 12UNF	4	50	340	(35)	(251)
Pump mission mounting bolt	1/2-13UNF	16	19	118	(12)	(87)
Pump device mounting bolt(Hexagon wrench)	20	12	17	390	(40)	(290)
Pump mounting bolt(Hexagon wrench)	16	4	14	205	(21)	(152)
Gear pump mounting bolt	27	2	22	137	(14)	(102)
Control valve mounting bolt	20	8	30	390	(40)	(290)
Swing control valve mounting bolt	16	3	17	49	(5)	(36)
Swing device mounting bolt	27	32	41	1370	(140)	(1010)
Swing motor mounting bolt	12	24	19	88	(9)	(65)
Battery mounting nut	12	2	19	34	(3.5)	(26)
Cab mounting bolt	16	8	24	265	(27)	(195)
Cab bed mounting bolt	16	58	24	205	(21)	(152)
Swing bearing mounting bolt(Upperstructure) (Undercarriage)	36	52	55	2750	(280)	(2030)
	36	50	55	2750	(280)	(2030)
Travel device mounting bolt	27	52	41	1370	(140)	(1010)
Travel motor mounting bolt	18	8	27	295	(30)	(215)
Sprocket mounting bolt	27	60	41	1370	(140)	(1010)
Upper roller mounting bolt	20	24	30	540	(55)	(400)
Lower roller mounting bolt	27	64	41	1370	(140)	(1010)
Shoe mounting bolt	30	416	46	2840	(290)	(2100)
Track guard mounting bolt	27	28	41	1370	(140)	(1010)
Side frame mounting bolt	42	52	65	3920	(400)	(2900)
Counterweight mounting bolt	45	6	63	3920	(400)	(2900)
Oil cooler mounting bolt	24	4	36	930	(95)	(690)
Front pin-retaining(Backhoe)						
Stopper bolt A	20	12	30	390	(40)	(290)
Stopper bolt B	20	12	30	390	(40)	(290)
Front pin-retaining>Loading shovel)						
Stopper bolt A	20	14	30	390	(40)	(290)
Stopper bolt B	20	4	17	540	(55)	(400)
Stopper bolt C	16	18	24	265	(27)	(195)
Stopper bolt D	12	6	19	88	(9)	(65)
Side cutter mounting bolt	33	12	50	2550	(260)	(1880)

GENERAL / Tightening

-  NOTE 1. Apply lubricant (e.g. white zinc B dissolved into spindle oil) to bolts and nuts to reduce friction coefficient of them.
2. Make sure bolt and nut threads are clean before installing.
 3. Apply LOCTITE to threads before installing and tightening swing bearing mounting bolts and lower roller mounting bolts.

GENERAL / Tightening

TORQUE CHART

CAUTION: Use tools appropriate for the work to be done. Makeshift tools and procedures can create safety hazards. For loosening and tightening nuts and bolts, use correct size tools. Otherwise, tightening tools may slip, potentially causing personal injury.



Bolt Types

Tighten nuts or bolts correctly to torque specifications. Four different types and grades of bolt are employed. Make sure to employ correct bolts and tighten them correctly when assembling the machine or components.

SA-040

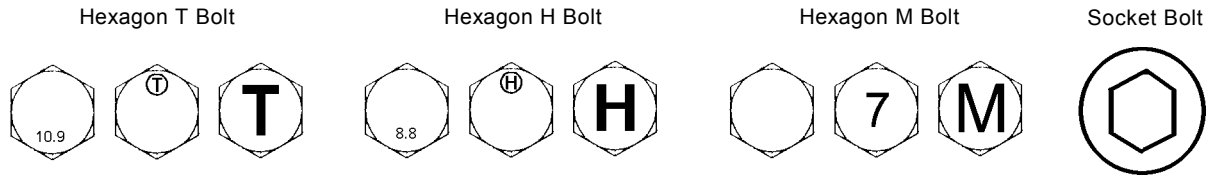

W162-01-01-001

Specified Tightening Torque Chart

Bolt Dia.	Wrench Size	Hexagon Wrench Size	T Bolt			H Bolt, Socket bolt			M Bolt		
			N·m	(kgf·m)	(lbf·ft)	N·m	(kgf·m)	(lbf·ft)	N·m	(kgf·m)	(lbf·ft)
M 8	13	6	29.5	(3)	(22)	19.5	(2)	(14.5)	9.8	(1)	(7.2)
M 10	17	8	64	(6.5)	(47)	49	(5)	(36)	19.5	(2)	(14.5)
M 12	19	10	108	(11)	(80)	88	(9)	(65)	34	(3.5)	(25.5)
M 14	22	12	175	(18)	(130)	137	(14)	(101)	54	(5.5)	(40)
M 16	24	14	265	(27)	(195)	205	(21)	(152)	78	(8)	(58)
M 18	27	14	390	(40)	(290)	295	(30)	(220)	118	(12)	(87)
M 20	30	17	540	(55)	(400)	390	(40)	(290)	167	(17)	(123)
M 22	32	17	740	(75)	(540)	540	(55)	(400)	215	(22)	(159)
M 24	36	19	930	(95)	(690)	690	(70)	(505)	275	(28)	(205)
M 27	41	19	1370	(140)	(1010)	1030	(105)	(760)	390	(40)	(290)
M 30	46	22	1910	(195)	(1410)	1420	(145)	(1050)	540	(55)	(400)
M 33	50	24	2550	(260)	(1880)	1910	(195)	(1410)	740	(75)	(540)
M 36	55	27	3140	(320)	(2310)	2400	(245)	(1770)	930	(95)	(690)

GENERAL / Tightening

IMPORTANT: The following items are applied to both fine and coarse pitch threads.

1. Apply lubricant (i. e. white zinc B dissolved into Spindle oil) to nuts and bolts to reduce their friction coefficients.
The plated bolts require no lubricant.
2. Torque tolerance is $\pm 10\%$.
3. Be sure to use bolts of correct length. Bolts that are too long cannot be tightened, as the bolt tip comes into contact with the bottom of the bolt hole. Bolts that are too short cannot develop sufficient tightening force.
4. The torques given in the chart are for general use only. Do not use these torques if a different torque is given for a specific application.
5. Make sure that nut and bolt threads are clean before installing.
Remove dirt or corrosion, if any.

Bolt Tightening Order

When tightening two or more bolts, tighten them alternately, as shown, to ensure even tightening.

Equally tighten upper and lower alter-

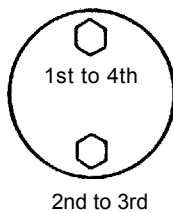

Tighten diagonally

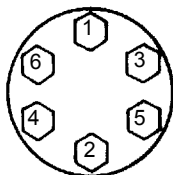

Tighten from center and diago-

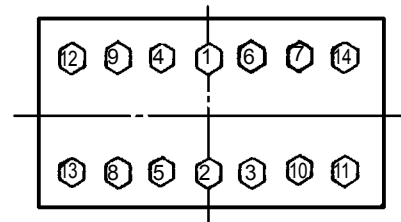

W105-01-01-003

GENERAL / Tightening

Service Recommendations for Split Flange

- IMPORTANT:**
1. Be sure to clean and inspect sealing surfaces. Scratches / roughness cause leaks and seal wear. Unevenness causes seal extrusion. If defects cannot be polished out, replace the component.
 2. Be sure to use only specified O-rings. Inspect O-rings for any damage. Take care not to file O-ring surfaces. When installing an O-ring into a groove, use grease to hold it in place.
 3. While lightly tightening split flange halves, check that split is centered and perpendicular to the port. Hand-tighten bolts to hold parts in place. Take care not to pinch the O-ring.
 4. Tighten bolts alternately and diagonally, as shown, to ensure even tightening.
 5. Do not use air wrenches. Using an air wrench often causes tightening of one bolt fully before tightening of the others, resulting in damage to O-rings or uneven tightening of bolts.

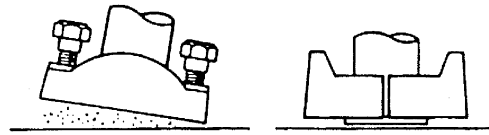

W105-01-01-015

WRONG

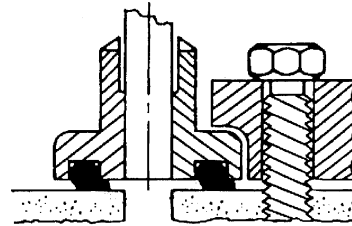

W105-01-01-016

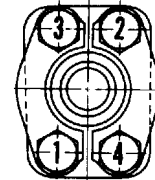

W105-01-01-008

RIGHT

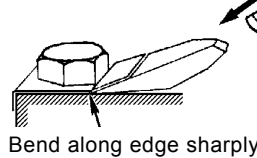

WRONG

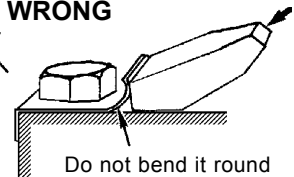

Nut and Bolt Locking

- Lock Plate

IMPORTANT: Do not reuse lock plates. Do not try to bend the same point twice.

- Cotter Pin

IMPORTANT: Do not reuse cotter pins. Match the holes in the bolt and nut while tightening, not while loosening.

- Lock Wire

IMPORTANT: Apply wire to bolts in the bolt-tightening direction, not in the bolt-loosening direction.

RIGHT

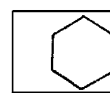

RIGHT

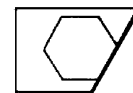

WRONG

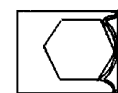

Bend along edge sharply

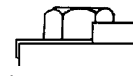

W105-01-01-009

RIGHT

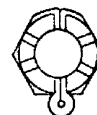

RIGHT



WRONG

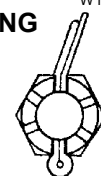

RIGHT

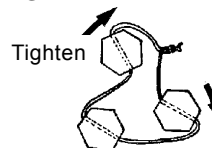

Loosen

WRONG

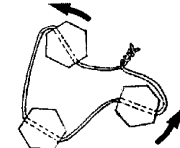

W105-01-01-010

GENERAL / Tightening

PIPING JOINT

IMPORTANT: The torques given in the chart are for general use only. Do not use these torques if a different torque is given for a specific application.

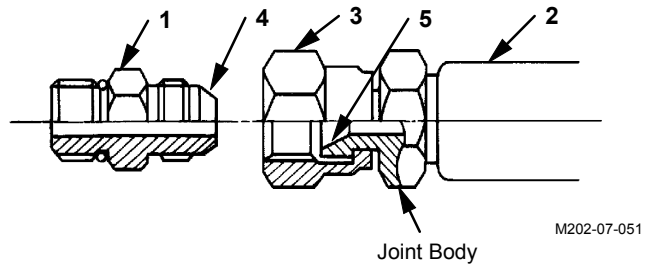

Union Joint

Metal sealing surfaces (4) and (5) of adapter (1) and hose (2) fit together to seal pressure oil. Union joints are used to join small-diameter lines.

- IMPORTANT:**
1. Do not over-tighten nut (3). Excessive force will be applied to metal sealing surfaces (4) and (5), possibly cracking adapter (1). Be sure to tighten nut (3) to specifications.
 2. Scratches or other damage to sealing surfaces (4) or (5) will cause oil leakage at the joint. Take care not to damage them when connecting/disconnecting.

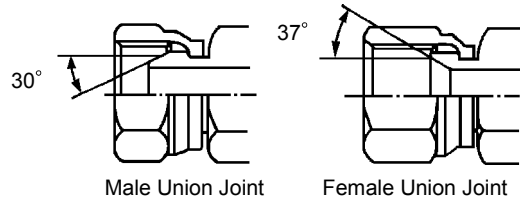

W105-01-01-017

Description	Wrench Size mm	Wrench Size mm	Tightening Torque
	Union Nut	Hose Fittings	N·m (kgf·m, lbf·ft)
30° male	17	17	24.5 (2.5,18)
	19	19	29.5 (3.0,21.5)
	22	22	39 (4.0,28.5)
	27	27	93 (9.5,69)
	32	32	137 (14.0,101)
	36	36	175 (18.0,129)
37° female	41	41	205 (21.0,151)
	17	14	24.5 (2.5,18)
	19	17	29.5 (3.0,21.5)
	22	19	39 (4.0,28.5)
	27	22	93 (9.5,69)
	32	27	137 (14.0,101)
	36	32	175 (18.0,129)
	41	36	205 (21.0,151)

NOTE: Tightening torque of 37° male coupling without union is similar to tightening torque of 37° female.

GENERAL / Tightening

O-ring Seal Joint

O-ring (6) seats against the end face of adapter (7) to seal pressure oil.

- IMPORTANT:**
1. Be sure to replace O-ring (6) with a new one when reconnecting.
 2. Before tightening nut (9), confirm that O-ring (6) is seated correctly in O-ring groove (e). Tightening nut (9) with O-ring (6) displaced will damage O-ring (6), resulting in oil leakage.
 3. Take care not to damage O-ring groove (e) or sealing surface (10). Damage to O-ring (6) will cause oil leakage.
 4. If nut (9) is loose and oil is leaking, do not re-tighten nut (9). Replace O-ring (6) with a new one and check that O-ring (6) is correctly seated in place, tighten nut (9).

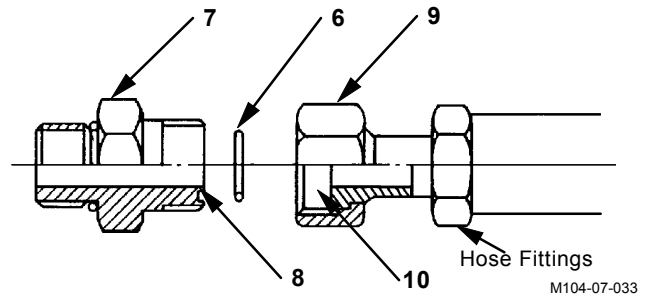

Wrench Size mm	Wrench Size mm	Tightening Torque
Union Nut	Hose Fittings	N·m (kgf·m, lbf·ft)
19	17	29.5 (3.0,21.5)
22	19	69 (7.0,51)
27	22	93 (9.5,69)
32	27	137 (14.0,101)
36	30,32	175 (18.0,129)
41	36	205 (21.0,151)
46	41	205 (21.0,151)

GENERAL / Tightening

Screw-In Connection

Depending on types of screw and sealing, different types of screw fittings are used.

IMPORTANT: Be sure to confirm that the thread pitch and thread type (tapered or straight) are the correct type before using any screw-in connection.

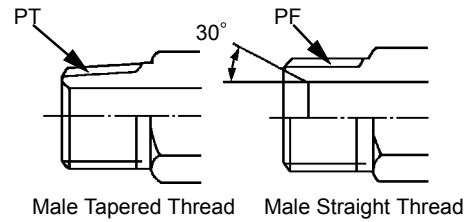

W105-01-01-018

Male Tapered Thread		
Wrench Size mm	Tightening Torque N·m (kgf·m, lbf·ft)	
Hose Fittings	FC material	SS material
19	14.5 (1.5,10.5)	34 (3.5,25)
22	29.5 (3.0,21.5)	49 (5.0,36)
27	49 (5.0,36)	93 (9.5,69)
36	69 (7.0,51)	157 (16,116)
41	108 (11,80)	205 (21,151)
50	157 (16,116)	320 (33,235)
60	195 (20,144)	

Seal Tape Application

Seal tape is used to seal clearances between male and female threads, so as to prevent any leaks between threads.

Be sure to apply just enough seal tape to fill up thread clearances. Do not overwrap.

• Application Procedure

Confirm that the thread surface is clean and, free of dirt or damage.

Apply seal tape around threads as shown. Wrap seal tape in the same direction as the threads.

Low-Pressure-Hose Clamp Tightening Torque

Low-pressure-hose clamp tightening torque differs depending on the type of clamp.

T-Bolt Type Band Clamp:

4.4 N·m (0.45 kgf·m, 3.25 lbf·ft)

Worm Gear Type Band Clamp:

5.9 to 6.9 N·m (0.6 to 0.7 kg·m, 4.3 to 5.1 lbf·ft)

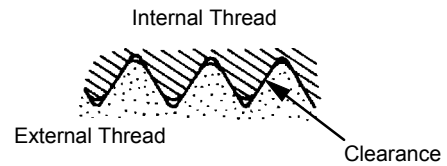

W105-01-01-019

Leave one to two pitch threads uncovered

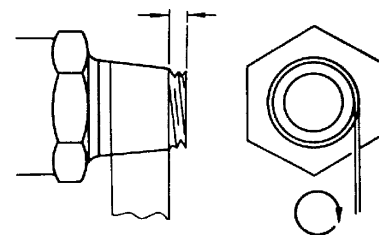

M114-07-041

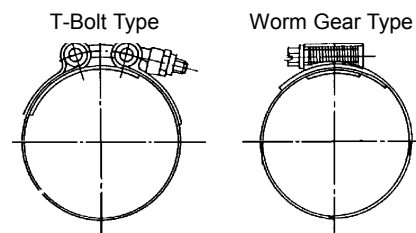

M114-07-043

M114-07-042

GENERAL / Tightening

Connecting Hose



CAUTION: When replacing hoses, be sure to use only genuine Hitachi service parts. Using hoses other than genuine Hitachi hoses may cause oil leaks, hose rupture or Separation of fitting, possibly resulting in a fire on the machine.

Do not install hoses kinked. Application of high oil pressure, vibration, or an impact to a kinked hose may result in oil leaks, hose rupture or separation of fitting. Utilize Print marks on hoses when installing to prevent hose from being kinked.

If hoses rub against each other, wear to the hoses will result, leading to hose rupture. Take necessary measures to protect hoses from rubbing against each other.

Take care so that hoses do not come into contact with moving parts or sharp objects.

WRONG

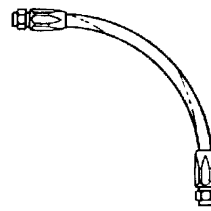

RIGHT

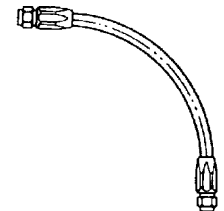

W105-01-01-011

WRONG

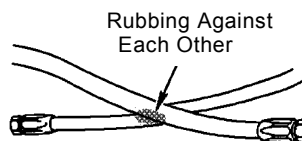

RIGHT

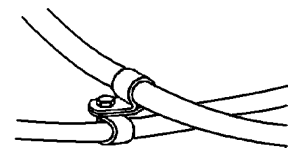

W105-01-01-012

WRONG

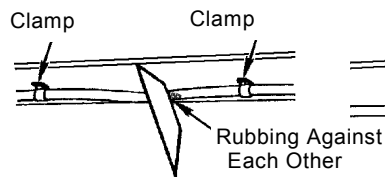

RIGHT

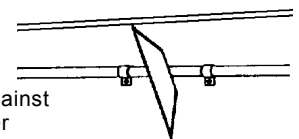

W105-01-01-013

WRONG

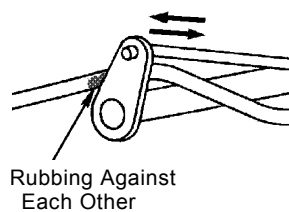

RIGHT

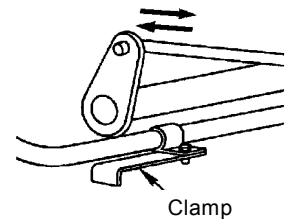

W105-01-01-014

GENERAL / Tightening

PERIODIC REPLACEMENT OF PARTS

To ensure safe operation, be sure to conduct periodic inspection of the machine. In addition, the parts listed below, if defective, may pose serious safety/fire hazards. It is very difficult to gauge the extent of deterioration, fatigue, or weakening of the parts listed below simply by visual inspection alone. For this reason, replace these parts at the intervals shown in the table below. However, if any of these parts are found to be defective, replace before starting operation, regardless of the interval.

Also, when replacing hoses, check the clamps for deformation, cracks, or other deterioration, and replace as necessary.

Be sure to perform periodic inspection of all hoses, as shown below, and replace or retighten any defective parts found, as necessary.

Consult your authorized dealer for correct replacement.

Periodic Replacement Parts		Replacement Intervals	
Engine	Fuel hose (Fuel tank to filter)	Every 2 years	
	Fuel hose (Fuel tank to injection pump)	Every 2 years	
	Heater hose (Heater to engine)	Every 2 years	
Hydraulic System	Base Machine	Pump suction hose	Every 2 years
		Pump delivery hose	Every 2 years
		Swing hose	Every 2 years
	Front Attachment	Boom cylinder line hose	Every 2 years
		Arm cylinder line hose	Every 2 years
		Bucket cylinder line hose	Every 2 years
		Pilot hose	Every 2 years

 **NOTE:** Be sure to replace seals, such as O-rings and gaskets, when replacing hoses.

SECTION 2 UPPERSTRUCTURE

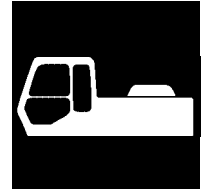

CONTENTS

Group 1 Cab

- Remove and Install Cab W2-1-1
- Dimensions of the Cab Glass W2-1-15

Group 2 Counterweight

- Remove and Install Counterweight W2-2-1

Group 3 Pump Device

- Remove and Install Pump Device W2-3-1
- Disassemble Pump Transmission..... W2-3-4
- Assemble Pump Transmission W2-3-6
- Disassemble Main Pump W2-3-8
- Assemble Main Pump..... W2-3-12
- Maintenance Standard W2-3-14
- Disassemble Regulator(Main Pump) . W2-3-16
- Assemble Regulator(Main Pump) W2-3-20
- Disassemble Pump of
 - Oil Cooler Fan Motor W2-3-26
- Assemble Pump of
 - Oil Cooler Fan Motor W2-3-30
- Maintenance Standard W2-3-32
- Disassemble Regulator(Pump for
 - Driving Oil Cooler Fan Motor) W2-3-34
- Assemble Regulator(Pump for
 - Driving Oil Cooler Fan Motor) W2-3-38
- Configuration of Pilot Pump W2-3-44
- Configuration of Pump for
 - Lubricating Pump Transmission..... W2-3-46

Group 4 Control Valve

- Remove and Install Control Valve W2-4-1
- Disassemble Main Control Valve 1
 - (5-Spool Section)..... W2-4-6
- Assemble Main Control Valve 1
 - (5-Spool Section)..... W2-4-10

- Disassemble Main Control Valve 2
 - (5-Spool Section)..... W2-4-16
- Assemble Main Control Valve 2
 - (5-Spool Section)..... W2-4-18
- Disassemble Main Control Valve 1
 - (4-Spool Section)..... W2-4-20
- Assemble Main Control Valve 1
 - (4-Spool Section)..... W2-4-28
- Disassemble Main Control Valve 2
 - (4-Spool Section)..... W2-4-34
- Assemble Main Control Valve 2
 - (4-Spool Section)..... W2-4-36
- Disassemble Manifold W2-4-38
- Assemble Manifold W2-4-40
- Disassemble Swing Control Valve 1... W2-4-42
- Assemble Swing Control Valve 1 W2-4-48
- Disassemble Swing Control Valve 2... W2-4-52
- Assemble Swing Control Valve 2 W2-4-54

Group 5 Swing Device

- Remove and Install Swing Device..... W2-5-1
- Disassemble Swing Reduction Gear.... W2-5-6
- Assemble Swing Reduction Gear..... W2-5-12
- Disassemble Swing Motor W2-5-16
- Assemble Swing Motor W2-5-20
- Disassemble and Assemble Swing
 - Parking Brake Releasing Valve W2-5-24
- Maintenance Standard..... W2-5-26

Group 6 Pilot Valve

- Remove and Install Right Pilot Valve ... W2-6-1
- Remove and Install Left Pilot Valve W2-6-5
- Remove and Install Travel Pilot Valve.
 - Remove and Install Bucket Pilot Valve(for Loading Shovel Only)..... W2-6-9
- Disassemble Front Pilot Valve W2-6-14
- Assemble Front Pilot Valve W2-6-18
- Disassemble Travel Pilot Valve..... W2-6-22
- Assemble Travel Pilot Valve W2-6-26
- Disassemble Pilot Valve for
 - Bucket Opening / Closing W2-6-32
- Assemble Pilot Valve for
 - Bucket Opening / Closing W2-6-34

Group 7 Pilot Shut-Off Valve

- Remove and Install
 - Pilot Shut-off Valve W2-7-1
- Disassemble Pilot Shut-off Valve W2-7-4
- Assemble Pilot Shut-off Valve..... W2-7-6

Group 8 Shockless Valve

- Remove and Install Front Attachment
 - Shockless Valve W2-8-1
- Disassemble and Assemble the
 - Shockless Valve W2-8-3

Group 9 Solenoid Valve

- Remove and Install Solenoid Valve..... W2-9-1
- Disassemble 2-Spool EHC Valve
 - (Boost Solenoid Valve, Control Solenoid Valve for Oil Cooler Fan) W2-9-4
- Assemble 2-Spool EHC Valve
 - (Boost Solenoid Valve, Control Solenoid Valve for Oil Cooler Fan) W2-9-6
- Configuration of Solenoid Valve W2-9-8

Group 10 Signal Control Valve

- Remove and Install Signal
 - Control Valve W2-10-1
 - Pilot Port W2-10-3

Group 11 Oil Cooler Fan Motor

- Remove and Install Oil Cooler
 - Fan Motor W2-11-1
- Disassemble Oil Cooler Fan Motor W2-11-4
- Assemble Oil Cooler Fan Motor W2-11-6

BUY NOW

**Then Instant Download
the Complete Manual
Thank you very much!**