

Workshop Manual

ZX

70-3

70LC-3

70LCN-3

75US-3

85US-3

Hydraulic Excavator

Service Manual consists of the following separate Part No.
Technical Manual (Operational Principle) : Vol. No.TO1P1-E
Technical Manual (Troubleshooting) : Vol. No.TT1P1-E
Workshop Manual : Vol. No.W1P1-E

SAFETY

RECOGNIZE SAFETY INFORMATION

- These are the **SAFETY ALERT SYMBOLS**.
 - When you see these symbols on your machine or in this manual, be alert to the potential for personal injury.
 - Follow recommended precautions and safe operating practices.

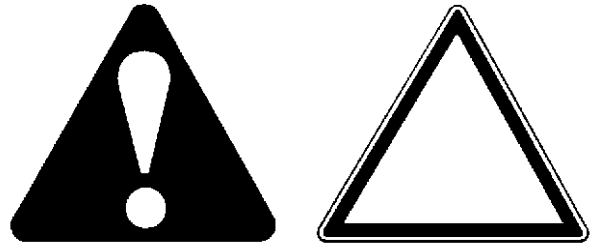

001-E01A-0001

SA-688

UNDERSTAND SIGNAL WORDS

- On machine safety signs, signal words designating the degree or level of hazard - **DANGER**, **WARNING**, or **CAUTION** - are used with the safety alert symbol.
 - **DANGER** indicates an imminently hazardous situation which, if not avoided, will result in death or serious injury.
 - **WARNING** indicates a potentially hazardous situation which, if not avoided, could result in death or serious injury.
 - **CAUTION** indicates a potentially hazardous situation which, if not avoided, may result in minor or moderate injury.
 - **DANGER** or **WARNING** safety signs are located near specific hazards. General precautions are listed on **CAUTION** safety signs.
 - Some safety signs don't use any of the designated signal words above after the safety alert symbol are occasionally used on this machine.
- To avoid confusing machine protection with personal safety messages, a signal word **IMPORTANT** indicates a situation which, if not avoided, could result in damage to the machine.
-  **NOTE** indicates an additional explanation for an element of information.

002-E01A-1223



SA-1223

SAFETY

FOLLOW SAFETY INSTRUCTIONS

- Carefully read and follow all safety signs on the machine and all safety messages in this manual.
- Safety signs should be installed, maintained and replaced when necessary.
 - If a safety sign or this manual is damaged or missing, order a replacement from your authorized dealer in the same way you order other replacement parts (be sure to state machine model and serial number when ordering).
- Learn how to operate the machine and its controls correctly and safely.
- Allow only trained, qualified, authorized personnel to operate the machine.
- Keep your machine in proper working condition.
 - Unauthorized modifications of the machine may impair its function and/or safety and affect machine life.
 - Do not modify any machine parts without authorization. Failure to do so may deteriorate the part safety, function, and/or service life. In addition, personal accident, machine trouble, and/or damage to material caused by unauthorized modifications will void Hitachi Warranty Policy.
 - Do not use attachments and/or optional parts or equipment not authorized by Hitachi. Failure to do so may deteriorate the safety, function, and/or service life of the machine. In addition, personal accident, machine trouble, and/or damage to material caused by using unauthorized attachments and/or optional parts or equipment will void Hitachi Warranty Policy.
- The safety messages in this SAFETY chapter are intended to illustrate basic safety procedures of machines. However it is impossible for these safety messages to cover every hazardous situation you may encounter. If you have any questions, you should first consult your supervisor and/or your authorized dealer before operating or performing maintenance work on the machine.

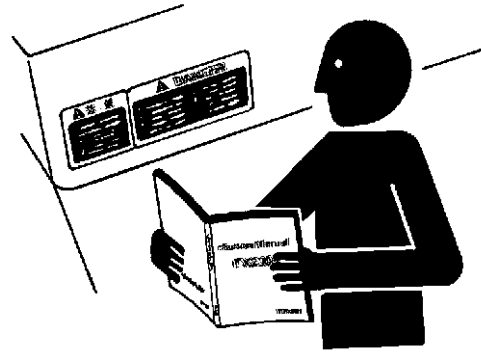

SA-003

003-E01B-0003

SAFETY

PREPARE FOR EMERGENCIES

- Be prepared if a fire starts or if an accident occurs.
 - Keep a first aid kit and fire extinguisher on hand.
 - Thoroughly read and understand the label attached on the fire extinguisher to use it properly.
 - To ensure that a fire-extinguisher can be always used when necessary, check and service the fire-extinguisher at the recommended intervals as specified in the fire-extinguisher manual.
 - Establish emergency procedure guidelines to cope with fires and accidents.
 - Keep emergency numbers for doctors, ambulance service, hospital, and fire department posted near your telephone.



SA-437

004-E01A-0437

WEAR PROTECTIVE CLOTHING

- Wear close fitting clothing and safety equipment appropriate to the job.

You may need:

- A hard hat
- Safety shoes
- Safety glasses, goggles, or face shield
- Heavy gloves
- Hearing protection
- Reflective clothing
- Wet weather gear
- Respirator or filter mask.

Be sure to wear the correct equipment and clothing for the job. Do not take any chances.

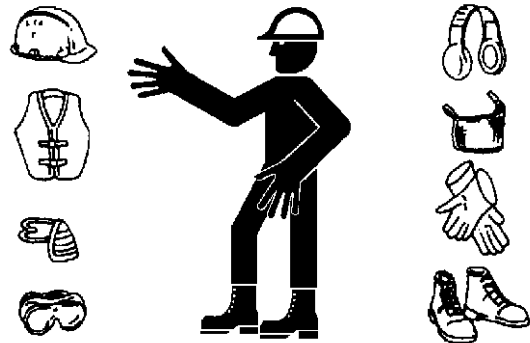

SA-428

- Avoid wearing loose clothing, jewelry, or other items that can catch on control levers or other parts of the machine.
- Operating equipment safely requires the full attention of the operator. Do not wear radio or music headphones while operating the machine.

005-E01A-0438

SAFETY

PROTECT AGAINST NOISE

- Prolonged exposure to loud noise can cause impairment or loss of hearing.
- Wear a suitable hearing protective device such as earmuffs or earplugs to protect against objectionable or uncomfortably loud noises.



006-E01A-0434

SA-434

INSPECT MACHINE

- Inspect your machine carefully each day or shift by walking around it before you start it to avoid personal injury.
- In the walk-around inspection be sure to cover all points described in the "RE-START INSPECTION" chapter in the operator's manual.



007-E01A-0435

SA-435

SAFETY

GENERAL PRECAUTIONS FOR CAB

- Before entering the cab, thoroughly remove all dirt and/or oil from the soles of your work boots. If any controls such as a pedal is operated while with dirt and/or oil on the soles of the operator's work boots the operator's foot may slip off the pedal, possibly resulting in a personal accident.
- Do not leave parts and/or tools lying around the operator's seat. Store them in their specified locations.
- Avoid storing transparent bottles in the cab. Do not attach any transparent type window decorations on the windowpanes as they may focus sunlight, possibly starting a fire.
- Refrain from listening to the radio, or using music headphones or mobile telephones in the cab while operating the machine.
- Keep all flammable objects and/or explosives away from the machine.
- After using the ashtray, always cover it to extinguish the match and/or tobacco.
- Do not leave cigarette lighters in the cab. When the temperature in the cab increases, the lighter may explode.

524-E01A-0000

**SECTION AND GROUP
CONTENTS**

SECTION 1 GENERAL

Group 1 Precautions for Disassembling
and Assembling

Group 2 Tightening

Group 3 Painting

Group 4 Bleeding Air from Hydraulic Oil
Tank

WORKSHOP MANUAL

SECTION 2 UPPERSTRUCTURE

Group 1 Cab

Group 2 Counterweight

Group 3 Main Frame

Group 4 Pump Device

Group 5 Control Valve

Group 6 Swing Device

Group 7 Pilot Valve

Group 8 Pilot Shut-Off Solenoid Valve

Group 9 Shockless Valve

Group 10 Solenoid Valve Unit

Group 11 Engine

SECTION 3 UNDERCARRIAGE

Group 1 Swing Bearing

Group 2 Travel Device

Group 3 Center Joint

Group 4 Track Adjuster

Group 5 Front Idler

Group 6 Upper and Lower Roller

Group 7 Track

SECTION 4 FRONT ATTACHMENT

Group 1 Front Attachment

Group 2 Cylinder

SECTION 5 ENGINE

Group 1 General Information

Group 2 Engine

SECTION 1 GENERAL



— CONTENTS —

Group 1 Precautions for Disassembling and Assembling

| | |
|---|--------|
| Precautions for Disassembling and Assembling | W1-1-1 |
| Maintenance Standard Terminology | W1-1-7 |

Group 2 Tightening

| | |
|---------------------------------------|--------|
| Tightening Torque Specifications..... | W1-2-1 |
| Torque Chart | W1-2-2 |
| Piping Joint | W1-2-5 |
| Periodic Replacement of Parts..... | W1-2-9 |

Group 3 Painting

| | |
|---------------|--------|
| Painting..... | W1-3-1 |
|---------------|--------|

Group 4 Bleeding Air from Hydraulic Oil Tank

| | |
|--|--------|
| Bleed Air from Hydraulic Oil Tank..... | W1-4-1 |
|--|--------|

GENERAL / Precautions for Disassembling and Assembling

PRECAUTIONS FOR DISASSEMBLING AND ASSEMBLING

Precautions for Disassembling and Assembling

- Clean the Machine

Thoroughly wash the machine before bringing it into the shop. Bringing a dirty machine into the shop may cause machine components to be contaminated during disassembling/assembling, resulting in damage to machine components, as well as decreased efficiency in service work.

- Inspect the Machine

Be sure to thoroughly understand all disassembling/assembling procedures beforehand, to help avoid incorrect disassembling of components as well as personal injury. Check and record the items listed below to prevent problems from occurring in the future.

- The machine model, machine serial number, and hour meter reading.
- Reason for disassembly (symptoms, failed parts, and causes).
- Clogging of filters and oil, water or air leaks, if any.
- Capacities and condition of lubricants.
- Loose or damaged parts.

- Prepare and Clean Tools and Disassembly Area

Prepare the necessary tools to be used and the area for disassembling work.

- Precautions for Disassembling

- To prevent dirt from entering, cap or plug the removed pipes.
- Before disassembling, clean the exterior of the components and place on a work bench.
- Before disassembling, drain gear oil from the reduction gear.
- Be sure to provide appropriate containers for draining fluids.
- Use matching marks for easier reassembling.
- Be sure to use the specified special tools, when instructed.
- If a part or component cannot be removed after removing its securing nuts and bolts, do not attempt to remove it forcibly. Find the cause(s), then take the appropriate measures to remove it.
- Orderly arrange disassembled parts. Mark and tag them as necessary.
- Store common parts, such as bolts and nuts with reference to where they are to be used and in a manner that will prevent loss.
- Inspect the contact or sliding surfaces of disassembled parts for abnormal wear, sticking, or other damage.
- Measure and record the degree of wear and clearances.

GENERAL / Precautions for Disassembling and Assembling

- Precautions for Assembling

- Be sure to clean all parts and inspect them for any damage. If any damage is found, repair or replace part.
- Dirt or debris on the contact or sliding surfaces may shorten the service life of the machine. Take care not to contaminate any contact or sliding surfaces.
- Be sure to replace O-rings, backup rings, and oil seals with new ones once they are disassembled. Apply a film of grease before installing.
- Be sure that liquid-gasket-applied surfaces are clean and dry.
- If an anti-corrosive agent has been used on a new part, be sure to thoroughly clean the part to remove the agent.
- Utilize matching marks when assembling.
- Be sure to use the designated tools to assemble bearings, bushings and oil seals.
- Keep a record of the number of tools used for disassembly/assembly. After assembling is complete, count the number of tools, so as to make sure that no forgotten tools remain in the assembled machine.

Bleeding Air from Hydraulic System

When hydraulic oil is drained, the suction filter or the suction lines are replaced, or the removal and installation of the pump, swing motor, travel motor or cylinder is done, bleed air from the hydraulic system in the following procedures:

IMPORTANT: If the engine is started with air trapped in the hydraulic pump housing, damage to the pump may result. If the hydraulic motor is operated with air trapped in the hydraulic motor housing, damage to the motor may result. If the cylinder is operated with air trapped in the cylinder tube, damage to the cylinder may result. Be sure to bleed air before starting the engine.

- Bleeding Air from Hydraulic Pump

- Remove the air bleeding plug from the top of the pump and fill the pump housing with hydraulic oil.
- After the pump housing is filled with hydraulic oil, temporarily tighten the plug. Then, start the engine and run at slow idle speed.
- Slightly loosen the plug to bleed air from the pump housing until hydraulic oil oozes out.
- After bleeding all the air, securely tighten the plug.

- Bleeding Air from Travel Motor / Swing Motor

- With the drain plug / hose on travel motor / swing motor removed, fill the motor case with hydraulic oil.

GENERAL / Precautions for Disassembling and Assembling

- Bleeding Air from Hydraulic Circuit
 - After refilling hydraulic oil, start the engine. While operating each cylinder, swing motor and travel motor evenly, operate the machine under light loads for 10 to 15 minutes. Slowly start each operation (never fully stroke the cylinders during initial operation stage). As the pilot oil circuit has an air bleed device, air trapped in the pilot oil circuit will be bled while performing the above operation for approx. 5 minutes.
 - Reposition the front attachment to check hydraulic oil level.
 - Stop the engine. Recheck hydraulic oil level. Replenish oil as necessary.

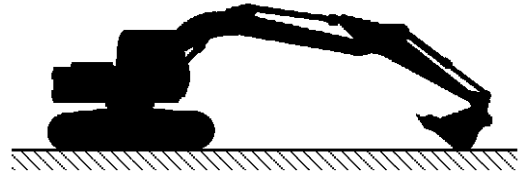

M1CC-07-002

GENERAL / Precautions for Disassembling and Assembling

Floating Seal Precautions

1. In general, replace the floating seal with a new one after disassembling.
If the floating seal is to be reused, follow these procedures:

- (1) Keep seal rings together as a matched set with seal ring faces together. Insert a piece of cardboard to protect surfaces. Apply oil to the sliding surface (C) on seal ring (A).
- (2) Check the slide surface (C) on seal ring (A) for scuffing, scoring, corrosion, deformation or uneven wear.
- (3) Check O-ring (B) for tears, breaks, deformation or hardening.

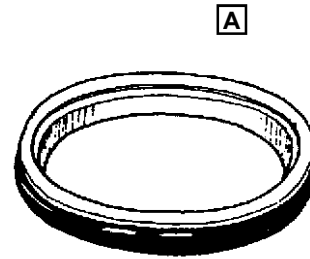

W105-03-05-019

2. If incorrectly assembled, oil leakage or damage will occur. Be sure to do the following, to prevent trouble.

- (1) Clean the floating seal and seal mounting bores with cleaning solvent. Use a wire brush to remove mud, rust or dirt. After cleaning, thoroughly dry parts with compressed air.
- (2) Clean the floating seal and seal mounting bores. Check the bore surface for scuffing or scoring by touching the surface.
- (3) Check that the O-ring is not twisted, and that it is installed correctly on the seal ring.
- (4) After installing the floating seal, check that seal ring surface (C) is parallel with seal mating face (D) by measuring the distances (C) and (D) at point (a) and (b), as illustrated. If these distances differ, correct the O-ring seating.

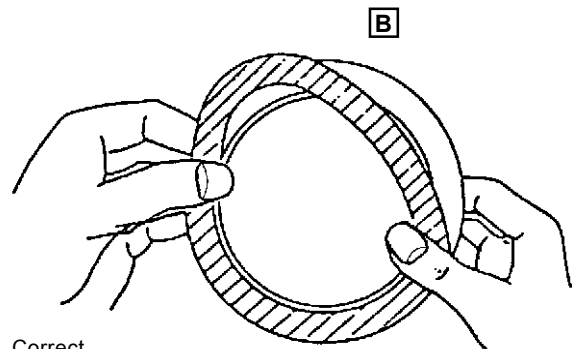

Correct

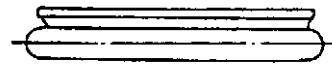

Incorrect

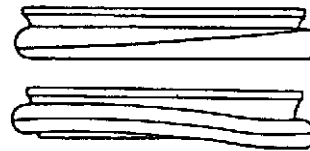

Correct

D

Incorrect

W105-03-05-020

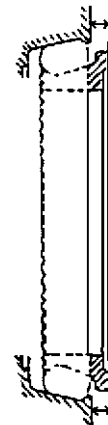

b

a=b

C

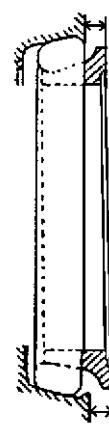

a

b

a ≠ b

W110-03-05-004

GENERAL / Precautions for Disassembling and Assembling

Precautions for Using Nylon Sling

1. Follow the precautions below to use nylon slings safely.
 - Attach protectors (soft material) on the corners of the load so that the nylon sling does not directly contact the corners. This will prevent the nylon sling from being damaged and the lifted load from slipping.
 - Lower the temperature of the lifted load to lower than 100 °C (212 °F). If unavoidably lifting a load with a temperature of 100 °C (212 °F) or more, reduce the load weight.
 - Do not lift acid or alkali chemicals.
 - Take care not to allow the sling to become wet. The load may slip.
 - When required to use more than one sling, use slings with the same width and length to keep the lifted load balanced.
 - When lifting a load using an eyehole, be sure to eliminate any gaps between the sling and load. (Refer to the right illustration.) Reduce the load weight so that it is less than 80 % of the sling breaking force.
 - Avoid using twisted, bound, connected, or hitched slings.
 - Do not place any object on twisted or bent slings. (Refer to the right illustration.)
 - When removing the slings from under the load, take care not to damage the nylon slings. Avoid contact with protrusions.
 - Avoid dragging slings on the ground, throwing slings or pushing slings with a metal object.
 - When using with other types of slings (wire rope) or accessories (shackle), protect the joint so that the nylon sling is not damaged.
 - Store the nylon slings indoors so they won't deteriorate with heat, sun light, or chemicals.

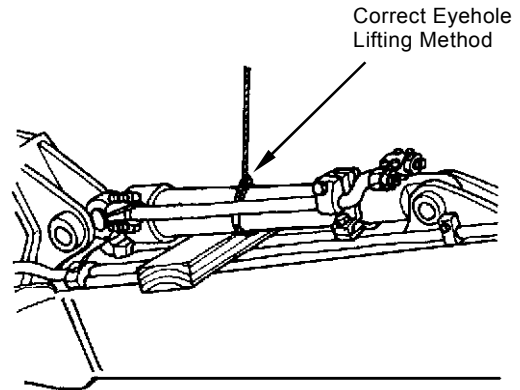

W102-04-02-016

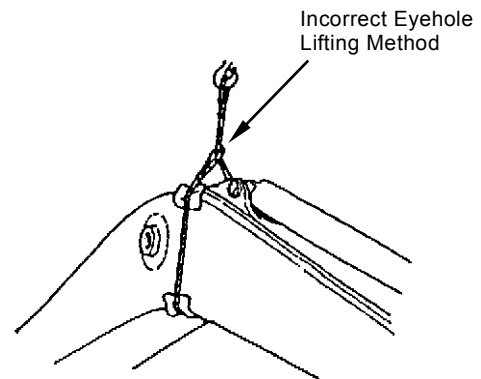

W105-04-01-008

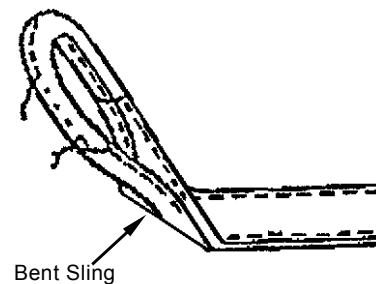

W162-01-01-009

GENERAL / Precautions for Disassembling and Assembling

CAUTION: If a load is lifted with a damaged nylon sling, serious personal injury may result. Be sure to visually check the nylon sling for any damage before using.

2. Before using a nylon sling, visually check the nylon sling for any damage corresponding to examples shown to the right. If any damage is found, cut and discard the sling. Even if no damage is found, do not use slings older than 7-years.

Damaged Appearance Broken Sewing Thread

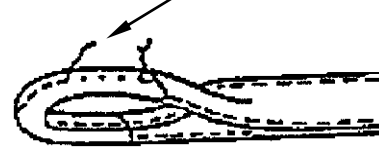

W162-01-01-002

Scuffing



W162-01-01-003

Fuzz

Broken Sewing Thread



W162-01-01-004

Broken Sewing Thread

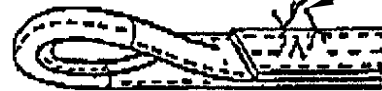

W162-01-01-005

Broken Sewing Thread



W162-01-01-006

Scoring

Separation of Belt



W162-01-01-007

Fuzz

Scuffing

Broken Warp



W162-01-01-008

GENERAL / Precautions for Disassembling and Assembling

MAINTENANCE STANDARD TERMINOLOGY

“Standard”

1. Dimension for parts on a new machine.
2. Dimension of new components or assemblies adjusted to specification.

“Allowable Limit”

1. Normal machine performance cannot be accomplished after exceeding this limit.
2. Repair or adjustment is impossible after exceeding this limit.
3. Therefore, in consideration of operation efficiency and maintenance expense, proper maintenance shall be carried out before reaching the “Allowable Limit”.

GENERAL / Tightening

TIGHTENING TORQUE SPECIFICATIONS

| No. | Descriptions | Bolt Dia | Q'ty | Wrench Size | Torque | | | |
|-----|---|-------------------------------------|------------------|-------------|--------------|----------------|--------------|-------|
| | | mm | | mm | N-m | (kgf-m) | (lbf-ft) | |
| 1 | Engine cushion rubber mounting bolt | 14 | 2 | 22 | 180 | (18.4) | (133) | |
| | | 16 | 2 | 24 | 270 | (27.5) | (200) | |
| 2 | Engine bracket mounting bolt | 10 | 8 | 17 | 50 | (5.1) | (37) | |
| | | 12 | 8 | 19 | 90 | (9.2) | (66) | |
| 3 | Hydraulic oil tank mounting bolt | 16 | 4 | 24 | 270 | (27.5) | (200) | |
| 4 | Fuel tank mounting bolt | 16 | 4 | 24 | 210 | (21.5) | (155) | |
| 5 | ORS fittings for hydraulic hoses and piping | | | 17 | 2.5 | (2) | (15) | |
| | | | | 19 | 29.5 | (3) | (22) | |
| | | | | 22 | 39 | (4) | (29) | |
| | | | | 27 | 93 | (9.5) | (69) | |
| | | | | 32 | 137 | (14) | (101) | |
| | | | | 36 | 175 | (18) | (129) | |
| | | 41 | 205 | (21) | (151) | | | |
| 6 | Pump mounting bolt | 18 | 2 | 27 | 300 | (30.5) | (220) | |
| 7 | Control valve mounting bolt | 14 | 3 | 22 | 180 | (18.4) | (133) | |
| 8 | Control valve bracket mounting bolt | ZX70-3, 70LC-3, 70LCN-3 | 12 | 4 | 19 | 90 | (9.2) | (66) |
| | | ZX75US-3, 85US-3 | 14 | 4 | 22 | 140 | (14.3) | (103) |
| 9 | Swing device mounting bolt | 16 | 10 | 24 | 210 | (21.5) | (155) | |
| 10 | Swing motor mounting bolt | 14 | 8 | 12 | 175 | (18) | (129) | |
| 11 | Battery mounting nut | 10 | 4 | 17 | 20 | (2.0) | (15.0) | |
| 12 | Cab mounting nut | 16 | 4 | 24 | 210 | (21.5) | (155) | |
| 13 | Swing bearing mounting bolt to upperstructure | 16 | 24 | 24 | 210 | (21.5) | (155) | |
| | Swing bearing mounting bolt to undercarriage | 16 | 24 | 24 | 270 | (27.5) | (200) | |
| 14 | Travel device mounting bolt | 16 | 20 | 24 | 300 | (31) | (220) | |
| | Travel reduction device cover mounting bolt | 14 | 8 | 22 | 140 | (14.3) | (103) | |
| 15 | Sprocket mounting bolt | 16 | 24 | 24 | 270 | (27.5) | (200) | |
| 16 | Upper roller mounting bolt | 14 | 2 | 22 | 140 | (14.3) | (103) | |
| 17 | Lower roller mounting bolt | 14 | 40 | 22 | 245 | (25) | (180) | |
| 18 | Track shoe bolt | ZX70-3, 70LCN-3 | 14 | 304 | 22 | 245 | (25) | (180) |
| | | ZX70LC-3, 75US-3, 85US-3 | 14 | 320 | 22 | 245 | (25) | (180) |
| 19 | Cover mounting bolt | 6 | | 10 | 10 | (1) | (7.4) | |
| | | 18 | | 13 | 20 | (2) | (15) | |
| | | 10 | | 17 | 50 | (5.1) | (37) | |
| | | 12 | | 19 | 90 | (9.2) | (66) | |
| 20 | Flexible master coupling of low pressure piping | 8 | 4 | 13 | 10.3 to 12.4 | (1.05 to 1.26) | (7.6 to 9.1) | |
| 21 | Coupling of low pressure piping | | 4 | 9.5 | 4.4 | (0.45) | (3.3) | |
| | | T-bolt clamp of low pressure piping | Suction hose | 2 | 11 | 10 | (1.0) | (7.4) |
| | | | In-take air duct | 1 | 9.5 | 7.3 | (0.74) | (5.4) |
| | | | Radiator hose | 1 | 9.5 | 7.3 | (0.74) | (5.4) |
| 22 | Side-cutter mounting bolt | 20 | 6 | 30 | 540 | (55) | (400) | |

 NOTE: 1. Apply lubricant (e.g. white zinc B dissolved into spindle oil) to bolts and nuts to reduce friction coefficient of them.

2. Make sure bolt and nut threads are clean before installing.

GENERAL / Tightening

TORQUE CHART







⚠ CAUTION: Use tools appropriate for the work to be done. Makeshift tools and procedures can create safety hazards. For loosening and tightening nuts and bolts, use correct size tools. Otherwise, tightening tools may slip, potentially causing personal injury.



SA-040

Bolt Types

Tighten nuts or bolts correctly to torque specifications. Four different types and grades of bolt are employed. Make sure to employ correct bolts and tighten them correctly when assembling the machine or components.

| Bolt Dia. | Wrench Size | Hexagon Wrench Size |    <small>M552-07-091</small> Socket Bolt | | |    <small>M552-07-090</small> | | |  <small>M552-07-092</small> | | |
|-----------|-------------|---------------------|--|---------|----------|--|---------|----------|---|--------------|--------------|
| | | | N-m | (kgf.m) | (lbf.ft) | N-m | (kgf.m) | (lbf.ft) | N-m | (kgf.m) | (lbf.ft) |
| M6 | 10 | 5 | | | | | | | 3.3 to 4.2 | (0.3 to 0.4) | (2.4 to 3.0) |
| M8 | 13 | 6 | 30 | (3.0) | (21.5) | 20 | (2.0) | (14.5) | 10 | (1.0) | (7.2) |
| M10 | 17 | 8 | 65 | (6.5) | (47) | 50 | (5.0) | (36) | 20 | (2.0) | (14.5) |
| M12 | 19 | 10 | 110 | (11) | (80) | 90 | (9.0) | (65) | 35 | (3.5) | (25.5) |
| M14 | 22 | 12 | 180 | (18) | (130) | 140 | (14) | (101) | 55 | (5.5) | (40) |
| M16 | 24 | 14 | 270 | (27) | (195) | 210 | (21) | (152) | 80 | (8.0) | (58) |
| M18 | 27 | 14 | 400 | (40) | (290) | 300 | (30) | (215) | 120 | (12) | (87) |
| M20 | 30 | 17 | 550 | (55) | (400) | 400 | (40) | (290) | 170 | (17) | (123) |
| M22 | 32 | | 750 | (75) | (540) | 550 | (55) | (400) | 220 | (22) | (159) |
| M24 | 36 | | 950 | (95) | (690) | 700 | (70) | (510) | 280 | (28) | (205) |
| M27 | 41 | | 1400 | (140) | (1010) | 1050 | (105) | (760) | 400 | (40) | (290) |
| M30 | 46 | | 1950 | (195) | (1410) | 1450 | (145) | (1050) | 550 | (55) | (400) |
| M33 | 50 | | 2600 | (260) | (1880) | 1950 | (195) | (1410) | 750 | (75) | (540) |
| M36 | 55 | | 3200 | (320) | (2310) | 2450 | (245) | (1770) | 950 | (95) | (690) |

GENERAL / Tightening

IMPORTANT: The following items are applied to both fine and coarse pitch threads.

1. Apply lubricant (i. e. white zinc B dissolved into Spindle oil) to nuts and bolts to reduce their friction coefficients.
The plated bolts require no lubricant.
2. Torque tolerance is $\pm 10\%$.
3. Be sure to use bolts of correct length. Bolts that are too long cannot be tightened, as the bolt tip comes into contact with the bottom of the bolt hole. Bolts that are too short cannot develop sufficient tightening force.
4. The torques given in the chart are for general use only. Do not use these torques if a different torque is given for a specific application.
5. Make sure that nut and bolt threads are clean before installing.
Remove dirt or corrosion, if any.

Bolt Tightening Order

When tightening two or more bolts, tighten them alternately, as shown, to ensure even tightening.

Equally tighten upper and lower alternately

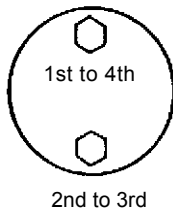

Tighten diagonally

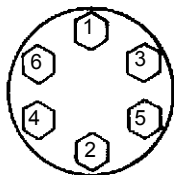

Tighten from center and diagonally

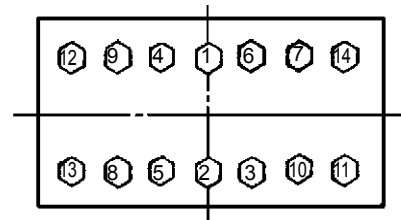

W105-01-01-003

GENERAL / Tightening

Service Recommendations for Split Flange

- IMPORTANT:**
1. Be sure to clean and inspect sealing surfaces. Scratches / roughness cause leaks and seal wear. Unevenness causes seal extrusion. If defects cannot be polished out, replace the component.
 2. Be sure to use only specified O-rings. Inspect O-rings for any damage. Take care not to file O-ring surfaces. When installing an O-ring into a groove, use grease to hold it in place.
 3. While lightly tightening split flange halves, check that split is centered and perpendicular to the port. Hand-tighten bolts to hold parts in place. Take care not to pinch the O-ring.
 4. Tighten bolts alternately and diagonally, as shown, to ensure even tightening.
 5. Do not use air wrenches. Using an air wrench often causes tightening of one bolt fully before tightening of the others, resulting in damage to O-rings or uneven tightening of bolts.

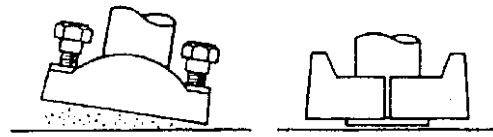

W105-01-01-015

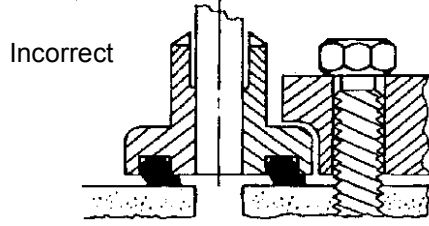

W105-01-01-016

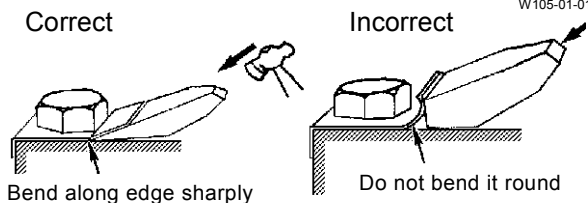
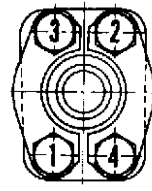

W105-01-01-008

Nut and Bolt Locking

- Lock Plate

IMPORTANT: Do not reuse lock plates. Do not try to bend the same point twice.

- Cotter Pin

IMPORTANT: Do not reuse cotter pins. Match the holes in the bolt and nut while tightening, not while loosening.

- Lock Wire

IMPORTANT: Apply wire to bolts in the bolt-tightening direction, not in the bolt-loosening direction.

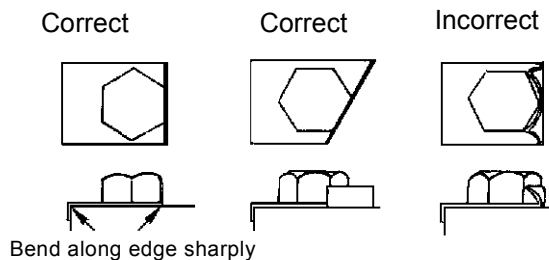

W105-01-01-009

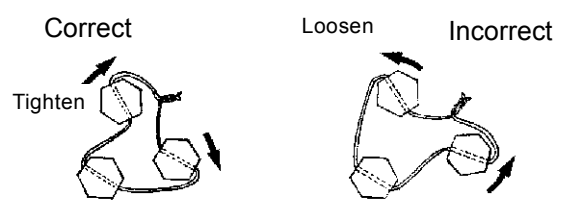
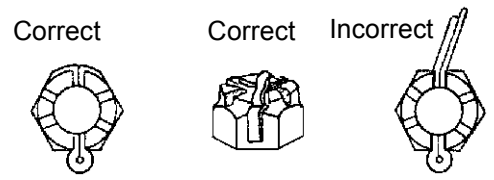

W105-01-01-010

GENERAL / Tightening

PIPING JOINT

IMPORTANT: The torques given in the chart are for general use only. Do not use these torques if a different torque is given for a specific application.

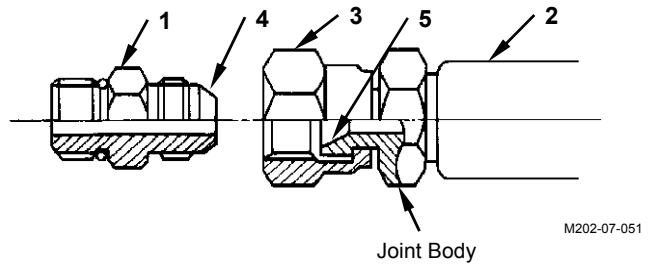

M202-07-051

Union Joint

Metal sealing surfaces (4) and (5) of adapter (1) and hose (2) fit together to seal pressure oil. Union joints are used to join small-diameter lines.

- IMPORTANT:**
1. Do not over-tighten nut (3). Excessive force will be applied to metal sealing surfaces (4) and (5), possibly cracking adapter (1). Be sure to tighten nut (3) to specifications.
 2. Scratches or other damage to sealing surfaces (4) or (5) will cause oil leakage at the joint. Take care not to damage them when connecting/disconnecting.

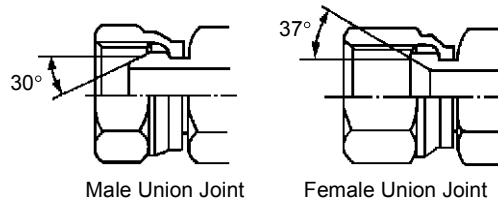

W105-01-01-017

| Description | Wrench Size mm | Wrench Size mm | Tightening Torque N·m (kgf·m, lbf·ft) |
|-------------|-------------------|-------------------|--|
| | Union Nut | Hose Fittings | |
| 30° male | 17 | 17 | 24.5 (2.5, 18) |
| | 19 | 19 | 29.5 (3.0, 21.5) |
| | 22 | 22 | 39 (4.0, 28.5) |
| | 27 | 27 | 93 (9.5, 69) |
| | 32 | 32 | 137 (14.0, 101) |
| | 36 | 36 | 175 (18.0, 129) |
| 37° female | 41 | 41 | 205 (21.0, 151) |
| | 17 | 14 | 24.5 (2.5, 18) |
| | 19 | 17 | 29.5 (3.0, 21.5) |
| | 22 | 19 | 39 (4.0, 28.5) |
| | 27 | 22 | 93 (9.5, 69) |
| | 32 | 27 | 137 (14.0, 101) |
| | 36 | 32 | 175 (18.0, 129) |
| | 41 | 36 | 205 (21.0, 151) |

NOTE: Tightening torque of 37° male coupling without union is similar to tightening torque of 37° female.

GENERAL / Tightening

O-ring Seal Joint

O-ring (6) seats against the end face of adapter (7) to seal pressure oil.

- IMPORTANT:**
1. Be sure to replace O-ring (6) with a new one when reconnecting.
 2. Before tightening nut (9), confirm that O-ring (6) is seated correctly in O-ring groove (e). Tightening nut (9) with O-ring (6) displaced will damage O-ring (6), resulting in oil leakage.
 3. Take care not to damage O-ring groove (8) or sealing surface (10).
Damage to O-ring (6) will cause oil leakage.
 4. If nut (9) is loose and oil is leaking, do not re-tighten nut (9). Replace O-ring (6) with a new one and check that O-ring (6) is correctly seated in place, tighten nut (9).

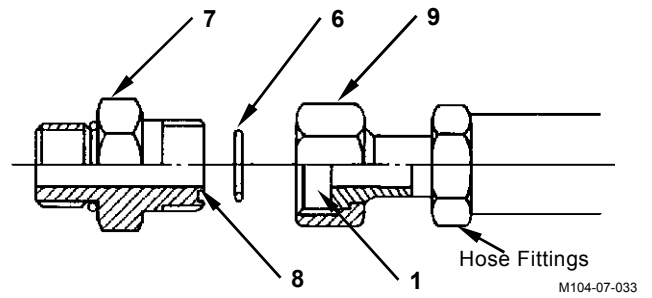

| Wrench Size mm | Wrench Size mm | Tightening Torque |
|-------------------|-------------------|---------------------|
| Union Nut | Hose Fittings | N·m (kgf·m, lbf·ft) |
| 19 | 17 | 29.5 (3.0, 21.5) |
| 22 | 19 | 69 (7.0, 51) |
| 27 | 22 | 93 (9.5, 69) |
| 32 | 27 | 137 (14.0, 101) |
| 36 | 30, 32 | 175 (18.0, 129) |
| 41 | 36 | 205 (21.0, 151) |
| 46 | 41 | 205 (21.0, 151) |

GENERAL / Tightening

Screw-In Connection

Depending on types of screw and sealing, different types of screw fittings are used.

IMPORTANT: Be sure to confirm that the thread pitch and thread type (tapered or straight) are the correct type before using any screw-in connection.

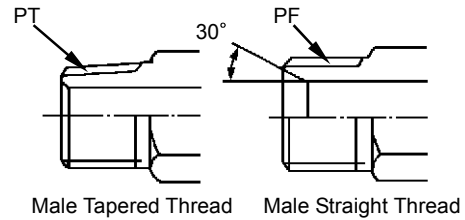

W105-01-01-018

| Male Tapered Thread | | |
|---------------------|--|---------------|
| Wrench Size mm | Tightening Torque N·m (kgf·m, lbf·ft) | |
| Hose Fittings | FC material | SS material |
| 19 | 14.5 (1.5, 10.5) | 34 (3.5, 25) |
| 22 | 29.5 (3.0, 21.5) | 49 (5.0, 36) |
| 27 | 49 (5.0, 36) | 93 (9.5, 69) |
| 36 | 69 (7.0, 51) | 157 (16, 116) |
| 41 | 108 (11, 80) | 205 (21, 151) |
| 50 | 157 (16, 116) | 320 (33, 235) |
| 60 | 195 (20, 144) | |

Seal Tape Application

Seal tape is used to seal clearances between male and female threads, so as to prevent any leaks between threads.

Be sure to apply just enough seal tape to fill up thread clearances. Do not overwrap.

- Application Procedure

Confirm that the thread surface is clean and, free of dirt or damage.

Apply seal tape around threads as shown. Wrap seal tape in the same direction as the threads.

Low-Pressure-Hose Clamp Tightening Torque

Low-pressure-hose clamp tightening torque differs depending on the type of clamp.

T-Bolt Type Band Clamp:
4.4 N·m (0.45 kgf·m, 3.25 lbf·ft)

Worm Gear Type Band Clamp:
5.9 to 6.9 N·m (0.6 to 0.7 kg·m, 4.3 to 5.1 lbf·ft)

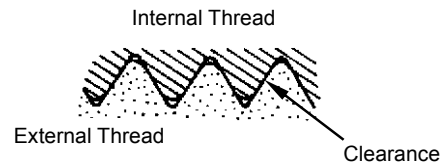

W105-01-01-019

Leave one to two pitch threads uncovered

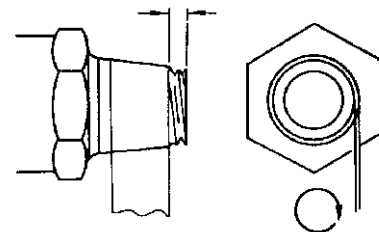

M114-07-041

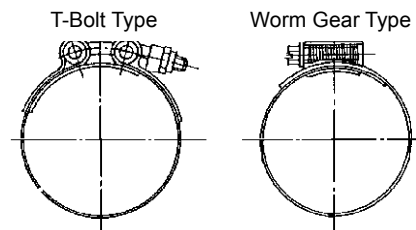

M114-07-043

M114-07-042

GENERAL / Tightening

Connecting Hose



CAUTION: When replacing hoses, be sure to use only genuine Hitachi service parts. Using hoses other than genuine Hitachi hoses may cause oil leaks, hose rupture or Separation of fitting, possibly resulting in a fire on the machine.

Do not install hoses kinked. Application of high oil pressure, vibration, or an impact to a kinked hose may result in oil leaks, hose rupture or separation of fitting. Utilize Print marks on hoses when installing to prevent hose from being kinked.

If hoses rub against each other, wear to the hoses will result, leading to hose rupture. Take necessary measures to protect hoses from rubbing against each other.

Take care so that hoses do not come into contact with moving parts or sharp objects.

Incorrect

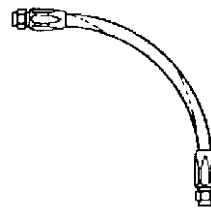

Correct

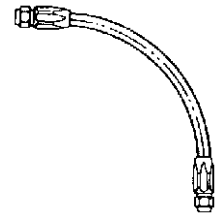

W105-01-01-011

Incorrect

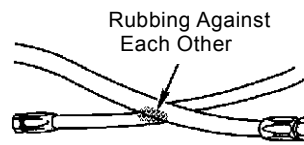

Correct

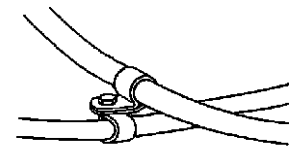

W105-01-01-012

Incorrect

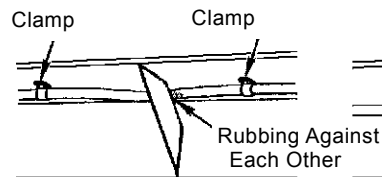

Correct

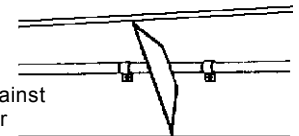

W105-01-01-013

Incorrect

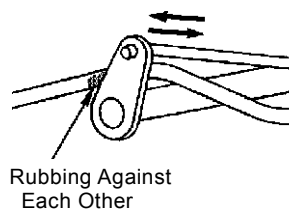

Correct

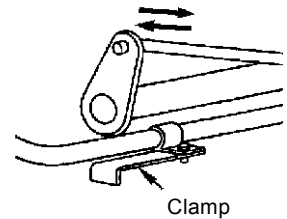

W105-01-01-014

GENERAL / Tightening

PERIODIC REPLACEMENT OF PARTS

To ensure safe operation, be sure to conduct periodic inspection of the machine. In addition, the parts listed below, if defective, may pose serious safety/fire hazards. It is very difficult to gauge the extent of deterioration, fatigue, or weakening of the parts listed below simply by visual inspection alone. For this reason, replace these parts at the intervals shown in the table below. However, if any of these parts are found to be defective, replace before starting operation, regardless of the interval.

Also, when replacing hoses, check the clamps for deformation, cracks, or other deterioration, and replace as necessary.

Be sure to perform periodic inspection of all hoses, as shown below, and replace or retighten any defective parts found, as necessary.

Consult your authorized dealer for correct replacement.

| Periodic Replacement Parts | | Replacement Intervals | |
|----------------------------|--|---------------------------|---------------|
| Engine | Fuel hose (Fuel tank to Supply pump) | Every 2 years | |
| | Oil filter hose (Engine to oil filter) | Every 2 years | |
| | Heater hose (Heater to engine) | Every 2 years | |
| Hydraulic System | Base Machine | Pump suction hose | Every 2 years |
| | | Pump delivery hose | Every 2 years |
| | | Swing hose | Every 2 years |
| | | Travel high pressure hose | Every 2 years |
| | Front Attachment | Boom cylinder line hose | Every 2 years |
| | | Arm cylinder line hose | Every 2 years |
| | | Bucket cylinder line hose | Every 2 years |
| Seat belt | | Every 3 years | |
| Clear hatch (If equipped) | | Every 5 years | |

 **NOTE:** Replace seals, such as O-rings and gaskets, when replacing hoses.

GENERAL / Painting

PAINTING

Painting Specification

| Surfaces to Be Painted | Painting Colour |
|---|---------------------------|
| • Main surface of upperstructure (except cab) | YR-01[TAXI yellow] |
| Main frame | HG Beige Deep |
| • Front attachment | YR-01 [TAXI yellow] |
| • Track (including swing bearing) | PB5-01 [SP-424 Dark Gray] |
| • Floor plate | H4-224 [Beige] |

Final Painted Colour

| | |
|--|---|
| • Inside and outside surface of cab | HG Beige Deep |
| Shaded area on cab[Left side only] | Shining Silver |
| • Right window guards, U-Bolt | [KANSAI PAINT LF-113-23DB (Charcoal series black, half glossy)] |
| • Suspension lifter | [TN2D(Black)] |
| • Lever (Travel, Pilot shut-off, foot rest) | High Grade Black |
| • Engine cover | YR-01 [TAXI yellow] |
| • Cover | HG Beige Deep |
| • Oil tank under cover | HG Beige Deep |
| • Handrail on upperstructure right side | HG Beige Deep |
| • Mirror stay | High Grade Black |
| • Camera cover | HG Beige Deep |
| • Air conditioner bracket | Cation electric coating only |
| • Controller cover | [TN2D (Black)] |
| • Under cover | HG Beige Deep |
| • Boom foot pin | HG Beige Deep |
| • Standard pipe clamp | HG Beige Deep |
| • Grease maintenance plate | HG Beige Deep |

GENERAL / Painting

ZX70-3

Handrail on Upper structure Right Side
Fuel tank front cover

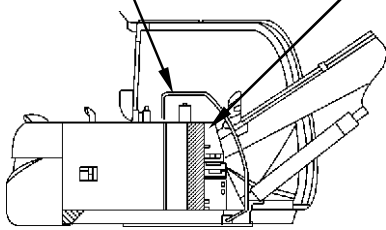

W1P1-01-03-001

Engine Cover
Camera Cover

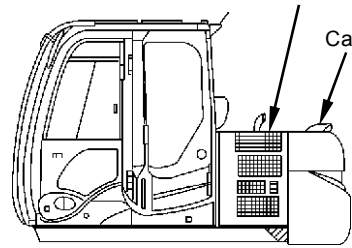

W1P1-01-03-002

ZX75US-3

Control valve Cover
Mirror Stay

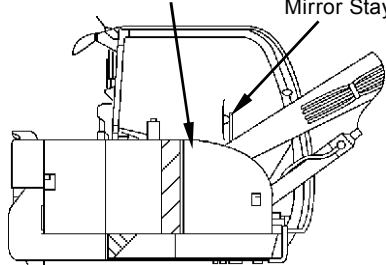

W1P1-01-03-003

Engine Cover
Camera Cover

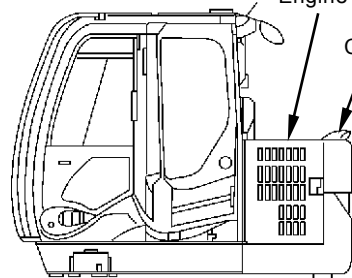

W1P1-01-03-004

GENERAL / Painting

ZX70-3

ZX75US-3

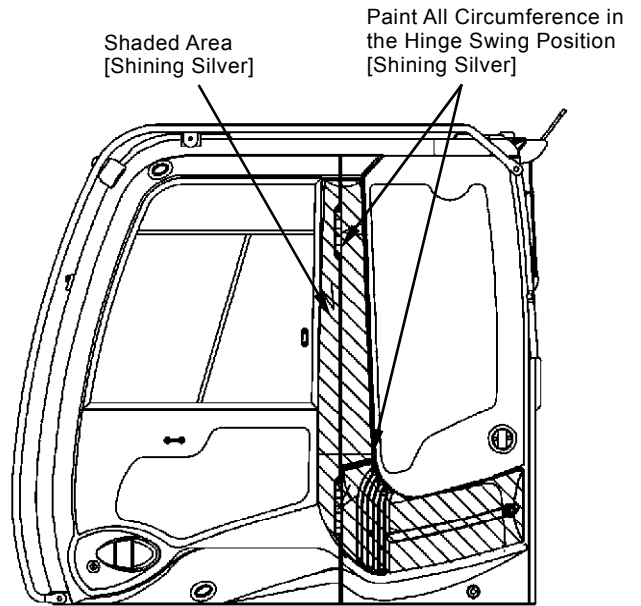
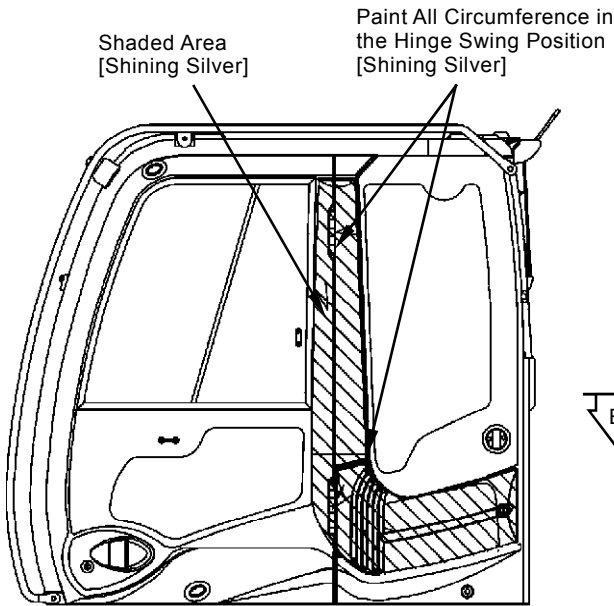

B

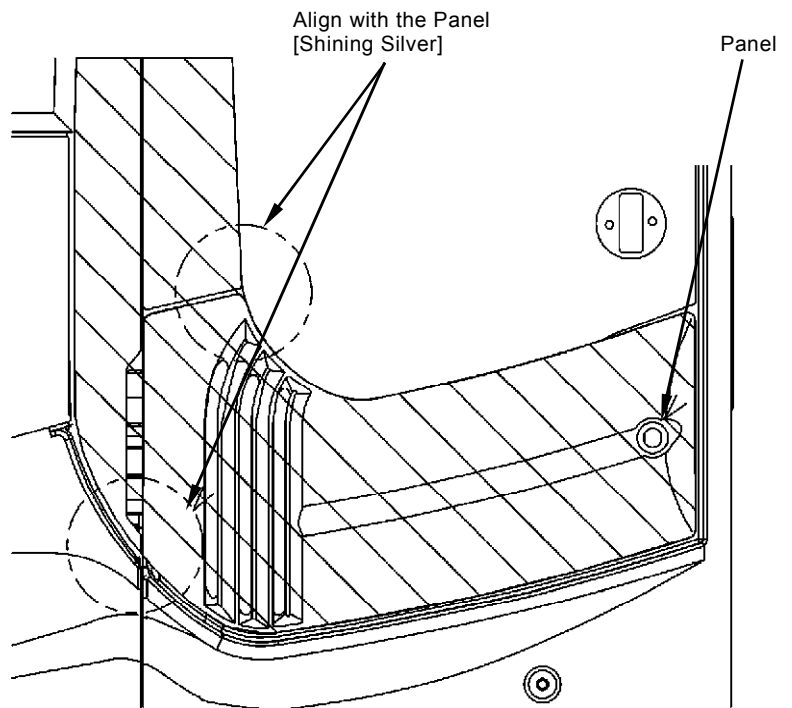
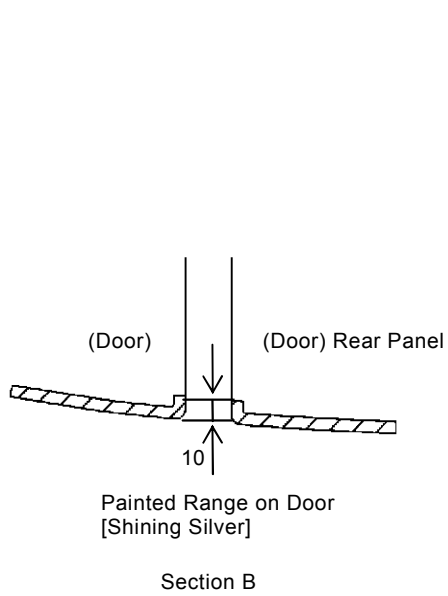

W1V1-01-03-004

BUY NOW

**Then Instant Download
the Complete Manual
Thank you very much!**