

**814, 816, 818,  
820, 822 and 825  
Cutting Platforms**  
from Serial No. 012050

**John Deere Werke Zweibrücken  
TM4533 (15JUN99)**

**European Version**

Printed in Germany  
**ENGLISCH**

### LIVE WITH SAFETY

Before returning machine to customer, make sure machine is functioning properly, especially the safety systems. Install all guards and shields.



DX,LIVE -19-15APR98

TS231 -19-07OCT88

### PREPARE FOR EMERGENCIES

Be prepared if a fire starts.

Keep a first aid kit and fire extinguisher handy.

Keep emergency numbers for doctors, ambulance service, hospital, and fire department near your telephone.

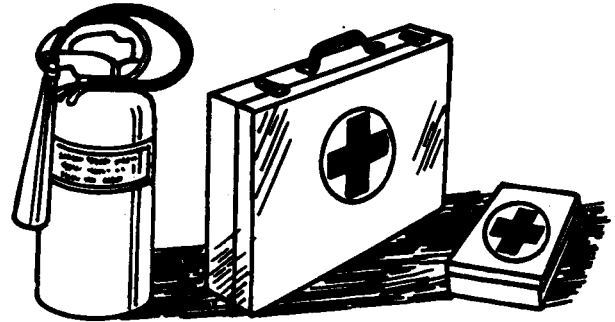

DX,FIRE2 -19-03MAR93

TS291 -JUN-23AUG88

### WORK IN CLEAN AREA

Before starting a job:

- Clean work area and machine.
- Make sure you have all necessary tools to do your job.
- Have the right parts on hand.
- Read all instructions thoroughly; do not attempt shortcuts.

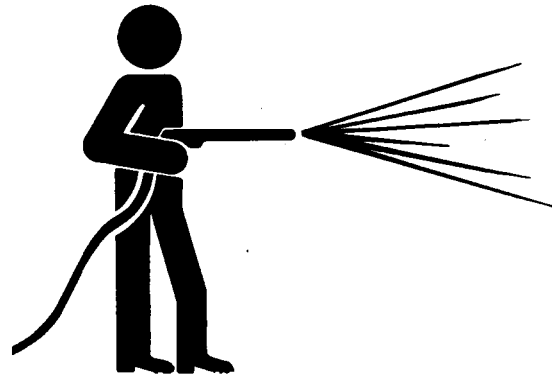

DX,CLEAN -19-04JUN90

T6642EJ -JUN-18OCT88

### WEAR PROTECTIVE CLOTHING

Wear close fitting clothing and safety equipment appropriate to the job.

Prolonged exposure to loud noise can cause impairment or loss of hearing.

Wear a suitable hearing protective device such as earmuffs or earplugs to protect against objectionable or uncomfortable loud noises.

Operating equipment safely requires the full attention of the operator. Do not wear radio or music headphones while operating machine.

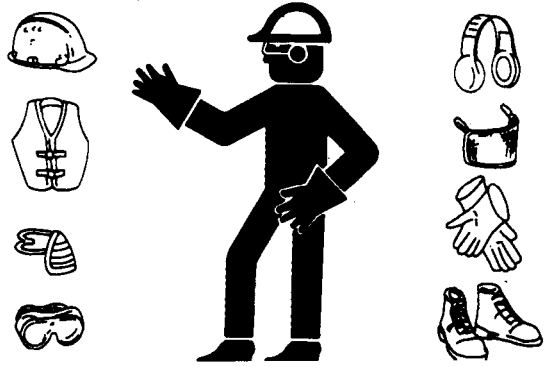

DX,WEAR -19-10SEP90

TS206 -JUN-23AUG88

### USE PROPER LIFTING EQUIPMENT

Lifting heavy components incorrectly can cause severe injury or machine damage.

Follow recommended procedure for removal and installation of components in the manual.

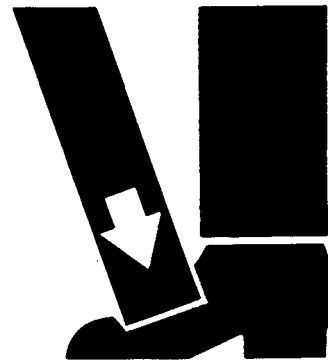

DX,LIFT -19-04JUN90

TS226 -JUN-23AUG88

### REPLACE SAFETY SIGNS

Replace missing or damaged safety signs. See the machine operator's manual for correct safety sign placement.



DX,SIGNS1 -19-04JUN90

TS201 -JUN-23AUG88

## PRACTICE SAFE MAINTENANCE

Understand service procedure before doing work. Keep area clean and dry.

Never lubricate, service, or adjust machine while it is moving. Keep hands, feet, and clothing from power-driven parts. Disengage all power and operate controls to relieve pressure. Lower equipment to the ground. Stop the engine. Remove the key. Allow machine to cool.

Securely support any machine elements that must be raised for service work.

Keep all parts in good condition and properly installed. Fix damage immediately. Replace worn or broken parts. Remove any buildup of grease, oil, or debris.

On self-propelled equipment, disconnect battery ground cable (-) before making adjustments on electrical systems or welding on machine.

On towed implements, disconnect wiring harnesses from tractor before servicing electrical system components or welding on machine.



-JUN-23AUG88

TS218

DX,SERV -19-04FEB99

## USE PROPER TOOLS

Use tools appropriate to the work. Makeshift tools and procedures can create safety hazards.

Use power tools only to loosen threaded parts and fasteners.

For loosening and tightening hardware, use the correct size tools. DO NOT use U.S. measurement tools on metric fasteners. Avoid bodily injury caused by slipping wrenches.

Use only service parts meeting John Deere specifications.



-JUN-08NOV89

TS779

DX,REPAIR -19-04JUN90

## AVOID HIGH-PRESSURE FLUIDS

Escaping fluid under pressure can penetrate the skin causing serious injury.

Avoid the hazard by relieving pressure before disconnecting hydraulic or other lines. Tighten all connections before applying pressure.

Search for leaks with a piece of cardboard. Protect hands and body from high pressure fluids.

If an accident occurs, see a doctor immediately. Any fluid injected into the skin must be surgically removed within a few hours or gangrene may result. Doctors unfamiliar with this type of injury should reference a knowledgeable medical source. Such information is available from Deere & Company Medical Department in Moline, Illinois, U.S.A.

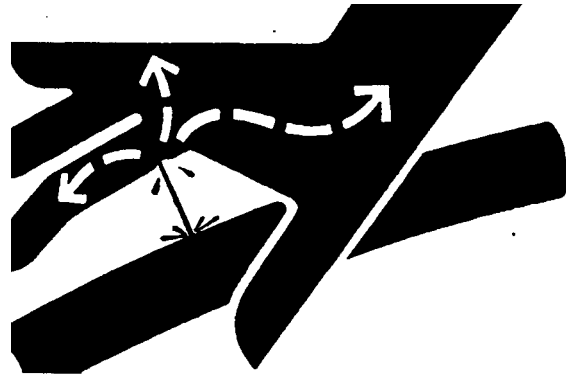

-JUN-23AUG88

X9811

DX,FLUID -19-03MAR93

## SUPPORT MACHINE PROPERLY

Always lower the attachment or implement to the ground before you work on the machine. If you must work on a lifted machine or attachment, securely support the machine or attachment. If left in a raised position, hydraulically supported devices can settle or leak down.

Do not support the machine on cinder blocks, hollow tiles, or props that may crumble under continuous load. Do not work under a machine that is supported solely by a jack. Follow recommended procedures in this manual.

When implements or attachments are used with a tractor, always follow safety precautions listed in the implement operator's manual.

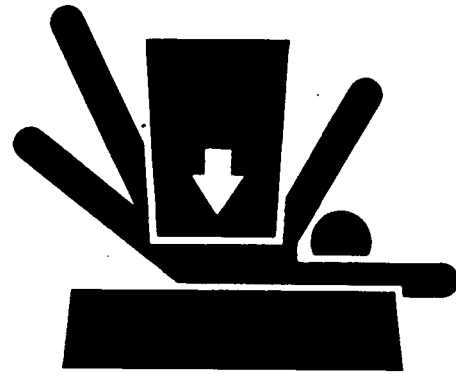

-JUN-23AUG88

TS229

DX,LOWER -19-04FEB99

## REMOVE PAINT BEFORE WELDING OR HEATING

Avoid potentially toxic fumes and dust.

Hazardous fumes can be generated when paint is heated by welding, soldering, or using a torch.

Do all work outside or in a well ventilated area. Dispose of paint and solvent properly.

Remove paint before welding or heating:

- If you sand or grind paint, avoid breathing the dust. Wear an approved respirator.
- If you use solvent or paint stripper, remove stripper with soap and water before welding. Remove solvent or paint stripper containers and other flammable material from area. Allow fumes to disperse at least 15 minutes before welding or heating.

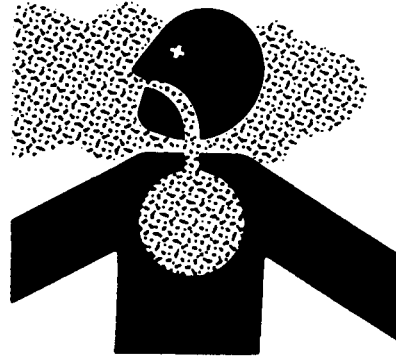

TS220 -JUN-23AUG88

DX,PAINT -19-03MAR93

## AVOID HEATING NEAR PRESSURIZED FLUID LINES

Flammable spray can be generated by heating near pressurized fluid lines, resulting in severe burns to yourself and bystanders. Do not heat by welding, soldering, or using a torch near pressurized fluid lines or other flammable materials. Pressurized lines can be accidentally cut when heat goes beyond the immediate flame area.



TSS953 -JUN-15MAY90

DX,TORCH -19-03MAR93

## HANDLE FLUIDS SAFELY—AVOID FIRES

When you work around fuel, do not smoke or work near heaters or other fire hazards.

Store flammable fluids away from fire hazards. Do not incinerate or puncture pressurized containers.

Make sure machine is clean of trash, grease, and debris.

Do not store oily rags; they can ignite and burn spontaneously.



TS227 -JUN-23AUG88

DX,FLAME -19-29SEP98

## DISPOSE OF WASTE PROPERLY

Improperly disposing of waste can threaten the environment and ecology. Potentially harmful waste used with John Deere equipment include such items as oil, fuel, coolant, brake fluid, filters, and batteries.

Use leakproof containers when draining fluids. Do not use food or beverage containers that may mislead someone into drinking from them.

Do not pour waste onto the ground, down a drain, or into any water source.

Air conditioning refrigerants escaping into the air can damage the Earth's atmosphere. Government regulations may require a certified air conditioning service center to recover and recycle used air conditioning refrigerants.

Inquire on the proper way to recycle or dispose of waste from your local environmental or recycling center, or from your John Deere dealer.

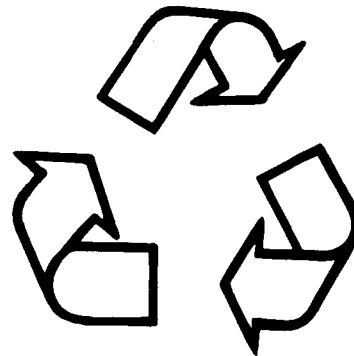

TS1133 -JUN-26NOV90

DX,DRAIN -19-03MAR93

### SERVICE MACHINES SAFELY

Tie long hair behind your head. Do not wear a necktie, scarf, loose clothing, or necklace when you work near machine tools or moving parts. If these items were to get caught, severe injury could result.

Remove rings and other jewelry to prevent electrical shorts and entanglement in moving parts.

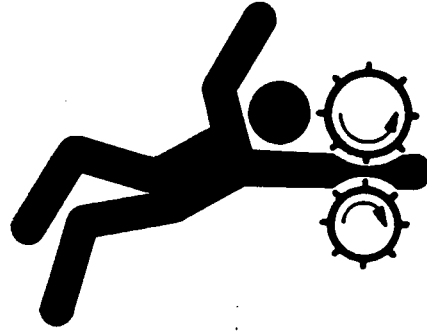

DX, LOOSE -19-04JUN90

TS228 -JUN-23AUG88

### ILLUMINATE WORK AREA SAFELY

Illuminate your work area adequately but safely. Use a portable safety light for working inside or under the machine. Make sure the bulb is enclosed by a wire cage. The hot filament of an accidentally broken bulb can ignite spilled fuel or oil.

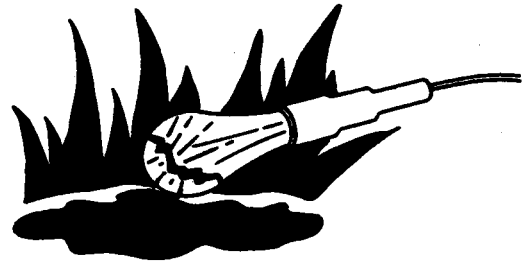







DX, LIGHT -19-04JUN90

TS223 -JUN-23AUG88

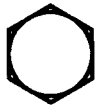
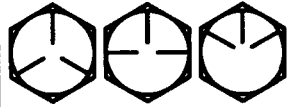
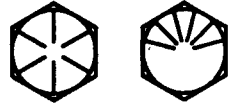

*Safety Measures*

**UNIFIED INCH BOLT AND CAP SCREW TORQUE VALUES**

<b>SAE Grade and Head Markings</b>	NO MARK	1 or 2 <sup>b</sup> 	5    5.1    5.2 	8    8.2 
<b>SAE Grade and Nut Markings</b>	NO MARK	2 	5  	8  

TS1162 -19-04/MAR91

Size	Grade 1				Grade 2 <sup>b</sup>				Grade 5, 5.1, or 5.2				Grade 8 or 8.2			
	Lubricated <sup>a</sup>		Dry <sup>a</sup>		Lubricated <sup>a</sup>		Dry <sup>a</sup>		Lubricated <sup>a</sup>		Dry <sup>a</sup>		Lubricated <sup>a</sup>		Dry <sup>a</sup>	
	N·m	lb-ft	N·m	lb-ft	N·m	lb-ft	N·m	lb-ft	N·m	lb-ft	N·m	lb-ft	N·m	lb-ft	N·m	lb-ft
1/4	3.7	2.8	4.7	3.5	6	4.5	7.5	5.5	9.5	7	12	9	13.5	10	17	12.5
5/16	7.7	5.5	10	7	12	9	15	11	20	15	25	18	28	21	35	26
3/8	14	10	17	13	22	16	27	20	35	26	44	33	50	36	63	46
7/16	22	16	28	20	35	26	44	32	55	41	70	52	80	58	100	75
1/2	33	25	42	31	53	39	67	50	85	63	110	80	120	90	150	115
9/16	48	36	60	45	75	56	95	70	125	90	155	115	175	130	225	160
5/8	67	50	85	62	105	78	135	100	170	125	215	160	240	175	300	225
3/4	120	87	150	110	190	140	240	175	300	225	375	280	425	310	550	400
7/8	190	140	240	175	190	140	240	175	490	360	625	450	700	500	875	650
1	290	210	360	270	290	210	360	270	725	540	925	675	1050	750	1300	975
1-1/8	400	300	510	375	400	300	510	375	900	675	1150	850	1450	1075	1850	1350
1-1/4	570	425	725	530	570	425	725	530	1300	950	1650	1200	2050	1500	2600	1950
1-3/8	750	550	950	700	750	550	950	700	1700	1250	2150	1550	2700	2000	3400	2550
1-1/2	1000	725	1250	925	990	725	1250	930	2250	1650	2850	2100	3600	2650	4550	3350

DO NOT use these values if a different torque value or tightening procedure is given for a specific application. Torque values listed are for general use only. Check tightness of fasteners periodically.

Fasteners should be replaced with the same or higher grade. If higher grade fasteners are used, these should only be tightened to the strength of the original.

Shear bolts are designed to fail under predetermined loads. Always replace shear bolts with identical grade.

Make sure fasteners threads are clean and that you properly start thread engagement. This will prevent them from failing when tightening.

Tighten plastic insert or crimped steel-type lock nuts to approximately 50 percent of the dry torque shown in the chart, applied to the nut, not to the bolt head. Tighten toothed or serrated-type lock nuts to the full torque value.

<sup>a</sup> "Lubricated" means coated with a lubricant such as engine oil, or fasteners with phosphate and oil coatings. "Dry" means plain or zinc plated without any lubrication.

<sup>b</sup> Grade 2 applies for hex cap screws (not hex bolts) up to 152 mm (6-in.) long. Grade 1 applies for hex cap screws over 152 mm (6-in.) long, and for all other types of bolts and screws of any length.

## METRIC BOLT AND CAP SCREW TORQUE VALUES

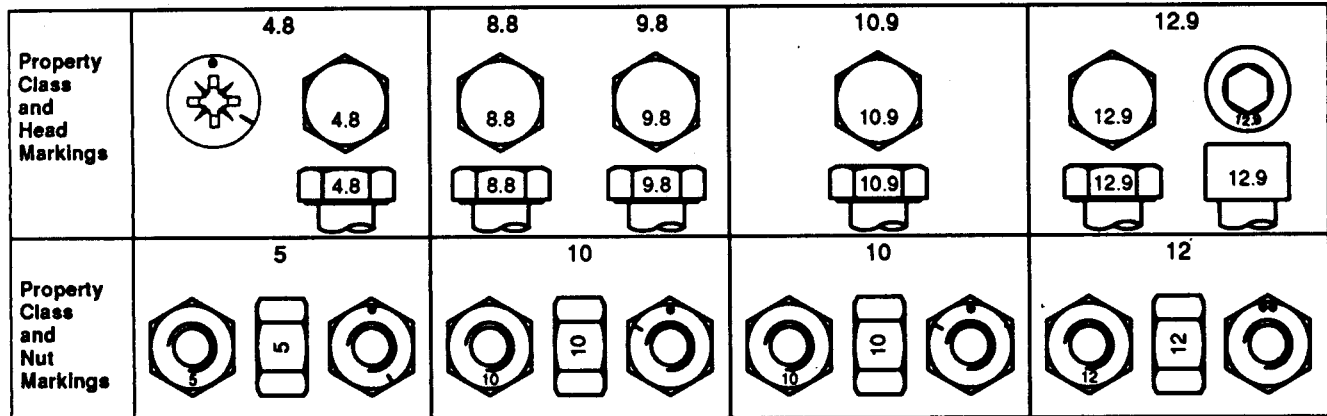

TS1163 -19-04/MAR91

Size	Class 4.8				Class 8.8 or 9.8				Class 10.9				Class 12.9			
	Lubricated <sup>a</sup>		Dry <sup>a</sup>		Lubricated <sup>a</sup>		Dry <sup>a</sup>		Lubricated <sup>a</sup>		Dry <sup>a</sup>		Lubricated <sup>a</sup>		Dry <sup>a</sup>	
	N-m	lb-ft	N-m	lb-ft	N-m	lb-ft	N-m	lb-ft	N-m	lb-ft	N-m	lb-ft	N-m	lb-ft	N-m	lb-ft
M6	4.8	3.5	6	4.5	9	6.5	11	8.5	13	9.5	17	12	15	11.5	19	14.5
M8	12	8.5	15	11	22	16	28	20	32	24	40	30	37	28	47	35
M10	23	17	29	21	43	32	55	40	63	47	80	60	75	55	95	70
M12	40	29	50	37	75	55	95	70	110	80	140	105	130	95	165	120
M14	63	47	80	60	120	88	150	110	175	130	225	165	205	150	260	190
M16	100	73	125	92	190	140	240	175	275	200	350	255	320	240	400	300
M18	135	100	175	125	260	195	330	250	375	275	475	350	440	325	560	410
M20	190	140	240	180	375	275	475	350	530	400	675	500	625	460	800	580
M22	260	190	330	250	510	375	650	475	725	540	925	675	850	625	1075	800
M24	330	250	425	310	650	475	825	600	925	675	1150	850	1075	800	1350	1000
M27	490	360	625	450	950	700	1200	875	1350	1000	1700	1250	1600	1150	2000	1500
M30	675	490	850	625	1300	950	1650	1200	1850	1350	2300	1700	2150	1600	2700	2000
M33	900	675	1150	850	1750	1300	2200	1650	2500	1850	3150	2350	2900	2150	3700	2750
M36	1150	850	1450	1075	2250	1650	2850	2100	3200	2350	4050	3000	3750	2750	4750	3500

DO NOT use these values if a different torque value or tightening procedure is given for a specific application. Torque values listed are for general use only. Check tightness of fasteners periodically.

Shear bolts are designed to fail under predetermined loads. Always replace shear bolts with identical property class.

Fasteners should be replaced with the same or higher property class. If higher property class fasteners are used, these should only be tightened to the strength of the original.

<sup>a</sup> "Lubricated" means coated with a lubricant such as engine oil, or fasteners with phosphate and oil coatings. "Dry" means plain or zinc plated without any lubrication.

Make sure fasteners threads are clean and that you properly start thread engagement. This will prevent them from failing when tightening.

Tighten plastic insert or crimped steel-type lock nuts to approximately 50 percent of the dry torque shown in the chart, applied to the nut, not to the bolt head. Tighten toothed or serrated-type lock nuts to the full torque value.

**IDENTIFICATION VIEWS**



ZX009855

820 Cutting Platform

-JUN-30OCT96  
ZX009855

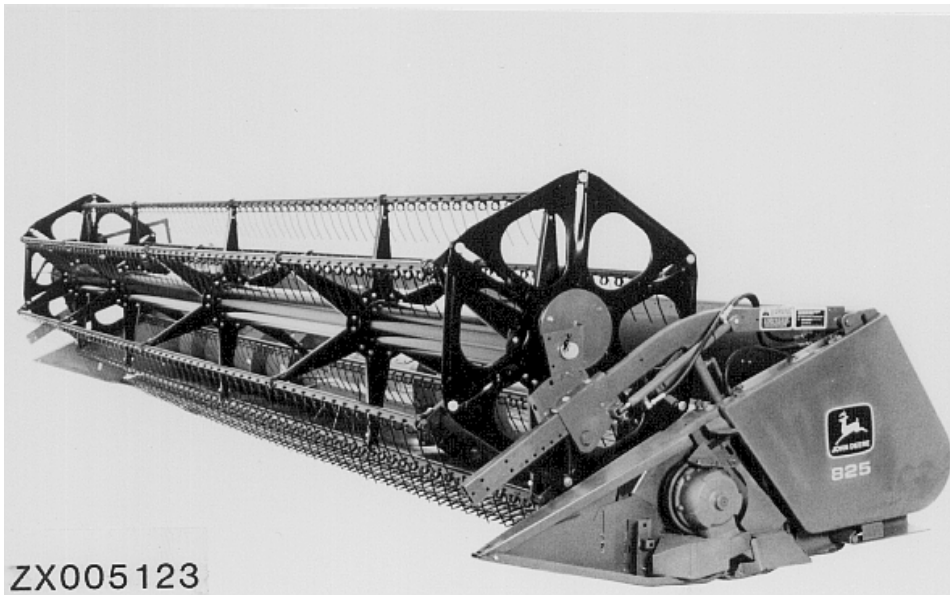

ZX005123

825 Cutting Platform

-JUN-07JUN95  
ZX005123

ZX.TMCUPL007111-19-15JAN99

## SERIAL NUMBER PLATE

- A—Serial number
- B—Year of production
- C—Permissible total weight
- D—Model designation

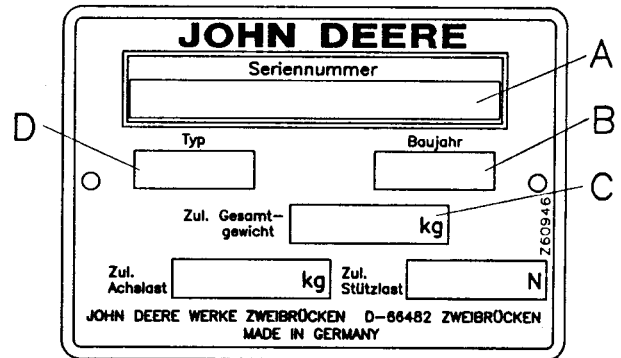

ZX006252

ZX,TMCUPL007109-19-01DEC96

-JUN-19APR95  
ZX006252

## PRODUCT IDENTIFICATION NUMBER

### On 814-820 Cutting Platforms:

The cutting platform serial number is displayed on a plate on the right-hand side of the platform.

When ordering parts, always quote the cutting platform serial number. This will help your dealer to give you prompt service.

### On 822 and 825 Cutting Platforms:

The platform serial number is displayed on a plate (A) on the left-hand side of the platform.

When ordering parts, always quote the platform serial number. This will help your dealer to give you prompt service.

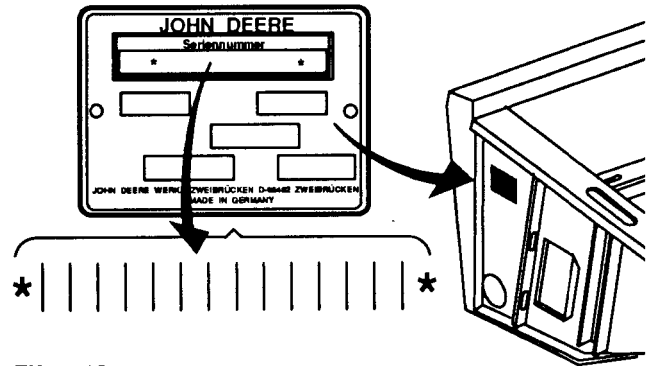

814-820 Cutting Platforms

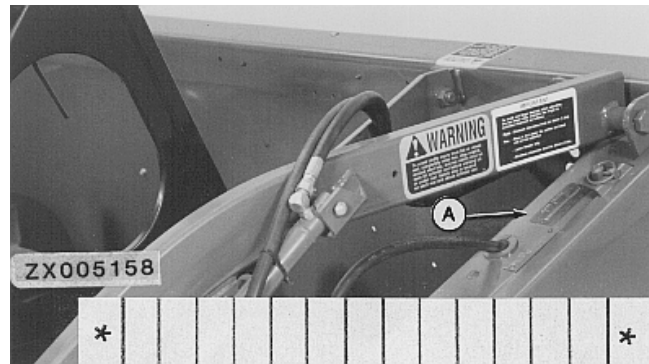

822 and 825 Cutting Platforms

ZX,TMCUPL007110-19-15JAN99

-JUN-19APR95  
ZX006251  
-JUN-06JUN95  
ZX005158

## CUTTING PLATFORM SPECIFICATIONS

### WEIGHTS

814: 4.25 m (14 ft)	1160 kg (2557 lb)
816: 4.85 m (16 ft)	1270 kg (2800 lb)
818: 5.50 m (18 ft)	1375 kg (3031 lb)
820: 6.10 m (20 ft)	1624 kg (3580 lb)
822: 6.55 m (22 ft)	1800 kg (3968 lb)
825: 7.60 m (25 ft)	2054 kg (4528 lb)

### CUTTING PLATFORM

Cutting height (ground to knife guard bar)	-120—1500 mm (-4.72—59 in.)
Ground clearance (ground to lowest point)	1200 ± 10 mm (47 ± 0.4 in.)
Gap between knife and auger	680—780 mm (26.8—30.7 in.)
Knife guard bar tilt adjusting range	9°
Knife guard bar extension adjustment	100 mm (4 in.)
Knife drive	Oil-bath transmission
Knife speed	1020 rpm
Cutting width:	
814	4.25 m (14 ft)
816	4.85 m (16 ft)
818	5.50 m (18 ft)
820	6.10 m (20 ft)
822	6.55 m (22 ft)
825	7.60 m (25 ft)
Knife section type:	
Finger bar knives	Heavy-duty overserrated (coarse)
Spare knife	Heavy-duty overserrated (fine)

ZX,TMCUPL007165-19-15JAN99

**CUTTING PLATFORM SPECIFICATIONS (CONTINUED)**

**REEL**

Reel diameter . . . . .	1100 mm (43.3 in.)
Number of reel bars . . . . .	6
Reel speed (814 - 820)	
13-tooth sprocket . . . . .	14—30 rpm
21-tooth sprocket . . . . .	22—50 rpm
Reel speed (825) . . . . .	5—44 rpm
Reel speed adjustment (standard) . . . . .	Electric
Reel speed adjustment (825) . . . . .	Hydraulic
Reel speed adjustment (optional) . . . . .	Automatic
Fore-and-aft adjustment range . . . . .	260 mm (10.2 in.)
Reel tine adjustment (one lever) . . . . .	60°

**AUGER**

Tube diameter . . . . .	410 mm (16.1 in.)
Diameter (flights included) . . . . .	610 mm (24 in.)
Length of auger fingers . . . . .	100 mm (4 in.)
Arrangement of auger fingers . . . . .	Spiral-shaped
Diameter of auger fingers . . . . .	16 mm (0.63 in.)
Number of auger fingers . . . . .	814: 18
	816—820: 26
	814 HD*: 24
	816 HD*: 32
	818 HD*: 34
	820 HD*: 34
	822: 20
	825: 20

**TOTAL PLATFORM WIDTH**

814 . . . . .	4665 mm (183.6 in.)
816 . . . . .	5275 mm (207.7 in.)
818 . . . . .	5886 mm (231.7 in.)
820 . . . . .	6590 mm (259.4 in.)
822 . . . . .	6700 mm (263.8 in.)
825 . . . . .	7800 mm (307.1 in.)

**TOTAL PLATFORM LENGTH**

Without dividers . . . . .	2300 mm (90.5 in.)
----------------------------	--------------------

\*HD means Heavy-Duty version.

**SPECIFICATIONS**

Item	Measurement	Specification
Knife drive case oil	Capacity	1 L (0.25 U.S. gal)
Self locking nut at knife head	Torque	225 N·m (166 lb-ft)
Knife head attaching screws	Torque	165 N·m (122 lb-ft)
Bellcrank to knife drive, slotted nut	Torque	240 N·m (177 lb-ft)
Knife drive attaching screws	Torque	240 N·m (177 lb-ft)
Knife attaching screws	Torque	13—14 N·m (9.6—10.3 lb-ft)
Housing cover attaching screws	Torque	45 N·m (30 lb-ft)
Bearing housing (yoke cap) to transmission housing, attaching screws	Torque	271 N·m (200 lb-ft)
Sheave attaching nut	Torque	150 N·m (110 lb-ft)
Wobble shaft special nut	Rolling drag torque	0.34—0.56 N·m (3—5 lb-ft)
Knife drive belt deflection	Dimension	20 mm (0.8 in.)
Knife drive belt tensioner spring length	Dimension	72 mm (2.8 in.)

ZX,TMCUPL007113-19-15JAN99

**OTHER MATERIAL**

Number	Name	Use
TY15130	Sealing compound	Knife drive housing cover

ZX,TMCUPL007114-19-01DEC96



## KNIFE GUARD BAR, KNIFE GUARDS AND KNIVES — COMPONENTS

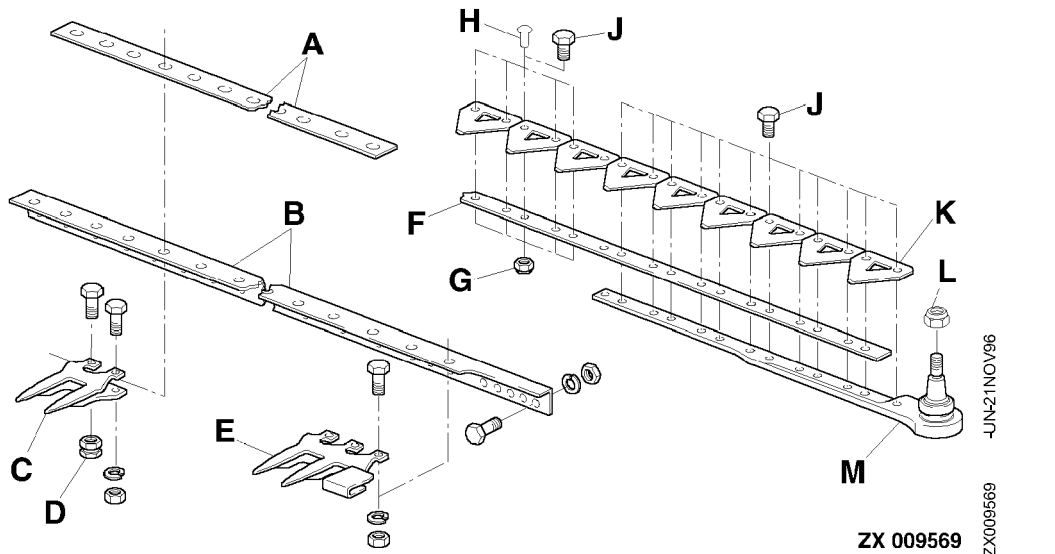

ZX 009569

A—Knife bar  
B—Knife guard bar  
C—Knife guard (two tine)  
D—Special nut

E—Knife guard (three tine)  
F—Back side of knife guard bar

G—Self-locking nut  
H—Rivet  
J—Cap screw

K—Knives  
L—Self-locking nut  
M—Knife head

ZX,TMCUPL007115-19-15JAN99

## REPLACING KNIVES

Remove cap screws (A).

Pull out knife (B) with knife head.

Attach knife head retainer (D) to replacement knife head (see "Replacing Knife Head Retainer").

Install new knife.

Insert cap screws (A) and tighten them by hand.

*NOTE: When installing cap screws (A) be sure to use special washers (G).*

Tighten nut (E) to 225 N·m (166 lb-ft).

Move knife (B) in elongated holes of knife head retainer (D) until it is centered between the knife guards (C).

Tighten cap screws (A) to 165 N·m (122 lb-ft).

*NOTE: After 50 hours of operation check torque of cap screws (A) and nut (E) and retighten, if necessary.*

**IMPORTANT:** Screw (F) of outer left-hand knife guard bar holds two spare special washers (G) and two spring washers for screws (A) as well as two special washers (H) for self-locking nut (E). Use only these washers as replacement parts.

- A—Cap screws
- B—Knife
- C—Knife guard
- D—Knife head retainer
- E—Self-locking nut
- F—Screw
- G—Special washers (spare)
- H—Special washers (spare)

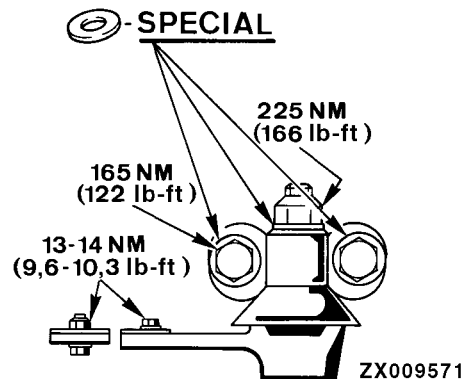
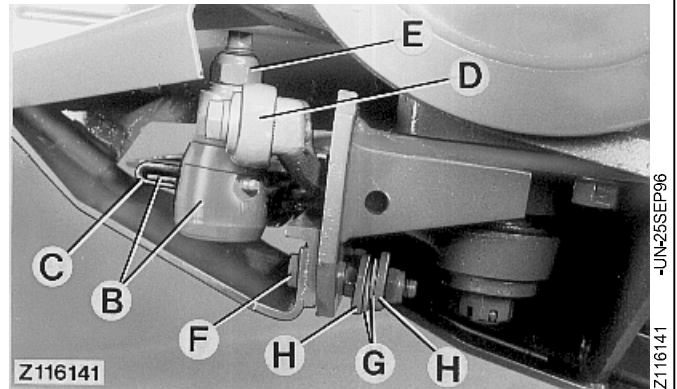
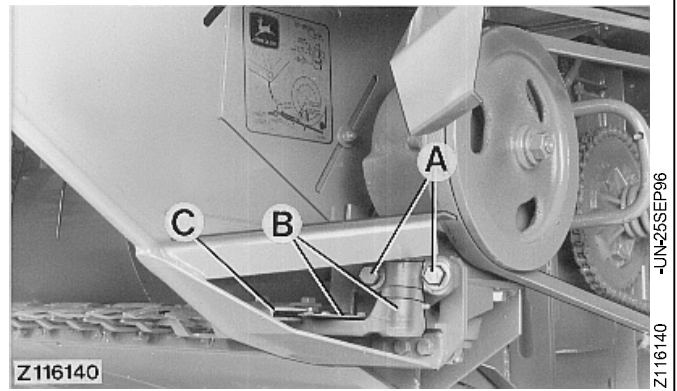

ZX.TMCUPL007116-19-15JAN99

**BUY NOW**

**Then Instant Download  
the Complete Manual  
Thank you very much!**