

HYDRAULIC EXCAVATOR

**SHOP
MANUAL**

model **SK40SR-2
SK45SR-2**

INDEX

1	SPECIFICATIONS
2	MAINTENANCE
3	SYSTEM
4	DISASSEMBLING
5	TROUBLESHOOTING
6	ENGINE
7	INSTALLATION PROCEDURES FOR OPTIONAL ATTACHMENT

MAINTENANCE SPECIFICATIONS

SYSTEM

DISASSEMBLING

TROUBLESHOOTING

OPT. E/G

KOBELCO

Book Code No. **S5PJ0002E** ①

00-0-1 ①



SK40SR-2
SK45SR-2

Index of shop Manual

Book Code No. Distribution Year-Month			Title	Index No.
S5PJ0102E 2001-10	S5PJ0102E ① 2003-01	SPECIFICATIONS	PRELIMINARY REMARKS	PJ01
S5PJ0202E 2001-10	S5PJ0202E ① 2003-01		SPECIFICATION	PJ02
S5PJ0302E 2001-10	S5PJ0302E ① 2003-01		ATTACHMENT	PJ03
S5PJ1102E 2001-10	S5PJ1102E ① 2003-01	MAINTENANCE	TOOLS	PJ11
S5PJ1202E 2001-10	S5PJ1202E ① 2003-01		STANDARD MAINTENANCE TIME TABLE	PJ12
S5PJ1302E 2001-10	S5PJ1302E ① 2003-01		MAINTENANCE STANDARD AND TEST PROCEDURE	PJ13
—	—	SYSTEM	MECHATRO CONTROL SYSTEM	
S5PJ2202E 2001-10	S5PJ2202E ① 2003-01		HYDRAULIC SYSTEM	PJ22
S5PJ2302E 2001-10	S5PJ2302E ① 2003-01		ELECTRICAL SYSTEM	PJ23
S5PJ2402E 2001-10	S5PJ2402E ① 2003-01		COMPONENTS SYSTEM	PJ24
—	—		—	
S5PJ3102E 2001-10	S5PJ3102E ① 2003-01	DISASSEMBLING	WHOLE DISASSEMBLING & ASSEMBLING	PJ31
S5PJ3202E 2001-10	S5PJ3202E ① 2003-01		ATTACHMENT	PJ32
S5PJ3302E 2001-10	S5PJ3302E ① 2003-01		UPPER STRUCTURE	PJ33
S5PJ3402E 2001-10	S5PJ3402E ① 2003-01		TRAVEL SYSTEM	PJ34
—	—	TROUBLESHOOTING	—	
S5PJ4202E 2001-10	S5PJ4202E ① 2003-01		HYDRAULIC SYSTEM	PJ42
S5PJ4302E 2001-10	S5PJ4302E ① 2003-01		ELECTRICAL SYSYEM	PJ43
S5PJ4402E 2001-10	S5PJ4402E ① 2003-01		ENGINE	PJ44
S5PJ5102E 2001-10	S5PJ5102E ① 2003-01	E/G	ENGINE	PJ51
		OPT.		
PH03-02001~ PJ02-00101~	PH04-02801~ PJ03-01001~		APPLICABLE MACHINES	

SAFETY PRECAUTIONS

1.1 GENERAL SAFETY INFORMATION

 **WARNING** 

Do Not operate or perform any maintenance on this machine until all instructions found in the OPERATION & MAINTENANCE MANUAL have been thoroughly read and understood. Improper operation or maintenance of this machine may cause accidents and could result in serious injury or death. Always keep the manual in the operator's seat pocket. If it is missing or damaged, place an order with an authorized KOBELCO Distributor for a replacement. If you have any questions, please consult an authorized KOBELCO Distributor.

1. Most accidents, which occur during operation, are due to neglect of precautionary measures and safety rules. Sufficient care should be taken to avoid these accidents. Erroneous operation, lubrication or maintenance services are very dangerous and may cause injury or death of personnel. Therefore all precautionary measures, NOTES, DANGERS, WARNINGS and CAUTIONS contained in this manual and on the machine should be read and understood by all personnel before starting any work with or on the machine.
2. Operation, inspection, and maintenance should be carefully carried out, and safety must be given the first priority. Messages of safety are indicated with marks. The safety information contained in this manual is intended only to supplement safety codes, insurance requirements, local laws, rules and regulations.
3. Messages of safety appear in this manual and on the machine. All messages of safety are identified by the words "DANGER", "WARNING" and "CAUTION".
 - a. **DANGER** – Indicates an imminently hazardous situation which, if not avoided, will result in death or serious injury and is represented as follows:

 **DANGER** 



- b. **WARNING** – Indicates a potentially hazardous situation which, if not avoided, could result in death or serious injury and is represented as follows:

 **WARNING** 

- c. **CAUTION** – Indicates a potentially hazardous situation which, if not avoided, may result in minor or moderate injury. It may also be used to alert against possible damage to the machine and its components and is represented as follows:

 **CAUTION** 

4. It is very difficult to forecast every danger that may occur during operation. However, safety can be ensured by fully understanding proper operating procedures for this machine according to methods recommended by KOBELCO.
5. While operating the machine, be sure to perform work with great care, so as not to damage the machine, or allow accidents to occur.
6. Continue studying this manual until all Safety, Operation and Maintenance procedures are completely understood by all persons working with the machine.

 **WARNING** 

The proper and safe lubrication and maintenance for this machine, recommended by KOBELCO, is outlined in the OPERATOR'S MANUAL for this machine. Improper performance of lubrication or maintenance procedures are dangerous and could result in injury or death. Read and understand the OPERATOR'S MANUAL before performing any lubrication or maintenance.

SAFETY PRECAUTIONS

1.2 SAFETY PRECAUTIONS

The serviceman or mechanic may be unfamiliar with many of the systems on this machine. This makes it important to use caution when performing service work. A knowledge of the system and or components is important before the removal or disassembly of any component.

Because of the size of some of the machine components, the serviceman or mechanic should check the weights noted in this manual. Use proper lifting procedures when removing any components. Weight of components table for SK40SR-2 / SK45SR-2 is shown in page 02-1-7, 8 of chapter SPECIFICATIONS in this manual.

The following is a list of basic precautions that must always be observed.

1. Read and understand all warning plates and decals on the machine before operating, maintaining or repairing this machine.
2. Always wear protective glasses and protective shoes when working around machines. In particular, wear protective glasses when using hammers, punches or drifts on any part of the machine or attachments. Use welders gloves, hood/goggles, apron and the protective clothing appropriate to the welding job being performed. Do not wear loose fitting or torn clothing. Remove all rings from fingers, loose jewelry, confine long hair and loose clothing before working on this machinery.
3. Disconnect the battery and hang a "Do Not Operate" tag in the operator's compartment. remove ignition keys.
4. If possible, make all repairs with the machine parked on a level, hard surface. Block the machine so it does not roll while working on or under the machine. Hang a "Do Not Operate" tag in the operator's compartment.
5. Do not work on any machine that is supported only by lift, jacks or a hoist. Always use blocks or jack stands, capable of supporting the machine, before performing any disassembly.
6. Relieve all pressure in air, oil or water systems before any lines, fittings or related items are disconnected or removed. Always make sure all raised components are blocked correctly and be alert for possible pressure when disconnecting any device from a system that utilizes pressure.
7. Lower the bucket, blade or other attachments to the ground before performing any work on the machine. If this cannot be done, make sure the bucket, blade or other attachment is blocked correctly to prevent it from dropping unexpectedly.
8. Use steps and grab handles when mounting or dismounting a machine. Clean any mud, grease, oil or debris from steps, walkways or work platforms before using. Always face the machine when using steps, ladders and walkways. When it is not possible to use the designed access system, provide ladders, scaffolds, or work platforms to perform safe repair operations.
9. To avoid back injury, use a hoist when lifting components which weigh 23 kg (50 lbs) or more. Make sure all chains, hooks, slings, etc., are in good condition and are the correct capacity. Be sure hooks are positioned correctly. Lifting eyes are not to be side loaded during a lifting operation.
10. To avoid burns, be alert for hot parts on machines which have just been stopped and hot fluids in lines, tubes and components.
11. Be careful when removing cover plates. Gradually back off the last two bolts or nuts located at opposite ends of the cover or device and carefully pry cover loose to relieve any spring or other pressure, before removing the last two bolts or nuts completely.
12. Be careful when removing filler caps, breathers and plugs on the machine. Hold a rag over the cap or plug to prevent being sprayed or splashed by liquids under pressure. The danger is even greater if the machine has just been stopped because fluids can be hot.



WARNING



Do not operate this machine unless you have read and understand the instructions in the OPERATOR'S MANUAL. Improper machine operation is dangerous and could result in injury or death.

SAFETY PRECAUTIONS

13. Always use the proper tools that are in good condition and that are suited for the job at hand. Be sure you understand how to use them before performing any service work.
14. Reinstall all fasteners with the same part number. Do not use a lesser quality fastener if replacements are necessary.
15. Repairs which require welding should be performed only with the benefit of the appropriate reference information and by personnel adequately trained and knowledgeable in welding procedures. Determine type of metal being welded and select correct welding procedure and electrodes, rods or wire to provide a weld metal strength equivalent at least to that of the parent metal. Make sure to disconnect battery before any welding procedures are attempted.
16. Do not damage wiring during removal operations. Reinstall the wiring so it is not damaged nor will be damaged in operation of the machine by contacting sharp corners, or by rubbing against some object or hot surface. Do not connect wiring to a line containing fluid.
17. Be sure all protective devices including guards and shields are properly installed and functioning correctly before starting a repair. If a guard or shield must be removed to perform the repair work, use extra caution and replace the guard or shield after repair is complete.
18. The maintenance and repair work while holding the bucket raised is dangerous due to the possibility of a falling attachment. Don't fail to lower the attachment and place the bucket to the ground before starting the work.
19. Loose or damaged fuel, lubricant and hydraulic lines, tubes and hoses can cause fires. Do not bend or strike high pressure lines or install ones which have been bent or damaged. Inspect lines, tubes and hoses carefully. Do not check for leaks with your hands. Very small (pin hole) leaks can result in a high velocity oil stream that will be invisible close to the hose. This oil can penetrate the skin and cause personal injury. Use cardboard or paper to locate pin hole leaks.
20. Tighten connections to the correct torque. Make sure that all heat shields, clamps and guards are installed correctly to avoid excessive heat, vibration or rubbing against other parts during operation. Shields that protect against oil spray onto hot exhaust components in event of a line, tube or seal failure must be installed correctly.
21. Do not operate a machine if any rotating part is damaged or contacts any other part during operation. Any high speed rotating component that has been damaged or altered should be checked for balance before reusing.
22. Be careful when servicing or separating the tracks. Chips can fly when removing or installing a track pin. Wear safety glasses and long sleeve protective clothing. Tracks can unroll very quickly when separated. Keep away from front and rear of machine. The machine can move unexpectedly when both tracks are disengaged from the sprockets. Block the machine to prevent it from moving.

KOBELCO

Book Code No.

S5PJ0102E ①

SHOP MANUAL SK40SR-2 PJ01 SK45SR-2

PRELIMINARY REMARKS

TABLE OF CONTENTS

- | | |
|--|-----|
| 1. GENERAL PRECAUTIONS FOR REPAIRS | 1-1 |
| 2. ESCAPING PROCEDURE IN CASE OF EMERGENCY | 1-4 |
| 3. INTERNATIONAL UNIT CONVERSION SYSTEM | 1-5 |

KOBELCO CONSTRUCTION MACHINERY CO., LTD.

Applicable Machines

SK40SR-2 : PH03-02001~
 : PH04-02801~
SK45SR-2 : PJ02-00101~
 : PJ03-01001~

Revision	Date of Issue	Remarks
First edition	October, 2001	S5PJ0102E K-E
First revision	January, 2003	S5PJ0102E① K-E

1. GENERAL PRECAUTIONS FOR REPAIRS



1.1 PREPARATION BEFORE DISASSEMBLING

- (1) Understanding operating procedure
Read OPERATION & MAINTENANCE MANUAL carefully to understand the operating procedure.
- (2) Cleaning machines
Remove soil, mud, and dust from the machine before carrying it into the service shop to prevent loss of work efficiency, damage of parts, and difficulty in rust prevention and dust protection while reassembling.
- (3) Inspecting machines
Identify the parts to be disassembled before starting work, determine the disassembling procedure by yourself considering the workshop situations etc., and request procurement of necessary parts in advance.
- (4) Recording
Record the following items for communication and prevention of recurring malfunction.
 - 1) Inspection date and place
 - 2) Model name, applicable machine number, and hour meter read
 - 3) Trouble condition, location and cause.
 - 4) Visible Oil leakage, water leakage and damage
 - 5) Clogging of filters, oil level, oil quality, oil contamination and loosening of connections
 - 6) Result of consideration if any problem exists based on the operation rate per month calculated from hour meter indication after the last inspection date.
- (5) Arrangement and cleaning in service shop
 - 1) Tools required for repair work.
 - 2) Prepare space to place the disassembled parts.
 - 3) Prepare oil containers for spilling oil etc.



1.2 SAFETY IN DISASSEMBLING AND ASSEMBLING

- 1) Wear appropriate clothes with long sleeves, safety shoes, safety helmet and protective glasses.
- 2) Suspend warning tag "DO NOT OPERATE" from the doorknob or the operating lever, and have a preliminary meeting before starting work.
- 3) Stop the engine before starting inspection and maintenance to prevent the operator being

caught in machine.

- 4) Identify the location of a first-aid kit and a fire extinguisher, and also where to make contact in a state of emergency.
- 5) Choose a hard, level and safe place, and place the attachment on the ground securely.
- 6) Use a lifter such as a crane to remove heavy parts (20 kg [45 lbs] or more) from the machine.
- 7) Use proper tools, and replace or repair defective tools.
- 8) Support the machine and attachment with supports or blocks if the work is performed in the lifted condition.



1.3 DISASSEMBLING AND ASSEMBLING HYDRAULIC EQUIPMENT

- (1) Removing hydraulic equipment
 - 1) Before disconnecting pipes, release the hydraulic pressure of the system, or open the return side cover and take out the filter.
 - 2) Carefully drain oil of the removed pipes into a containers without spilling on the floor.
 - 3) Apply plugs or caps on the pipe ends to avoid oil spillage and dust intrusion.
 - 4) Clean off the external surface of the equipment before disassembling, and drain hydraulic and gear oil before placing it on the workbench.
- (2) Disassembling hydraulic equipment
 - 1) Do not disassemble, reassemble or modify the hydraulic equipment without the permission of the manufacturer, who is not responsible for the performance and function of the product after reassembling.
 - 2) When disassembling and reassembling for unavoidable reason, refer the work to qualified personnel who have the specific knowledge or completed the parts service training.
 - 3) Provide matching marks to facilitate reassembling work.
 - 4) Before starting the work, read the manual of disassembling procedure, if it is provided, and decide whether the work can be performed by yourself.
 - 5) Use the special jig and tools without fail if they are specified.
 - 6) If it is hard to remove a part according to the procedure, do not try it by force but investigate the cause.

- 7) Place the removed parts in order and attach tags to facilitate the reassembling.
 - 8) Note the location and quantity of parts commonly applied to multiple locations.
- (3) Inspecting parts
- 1) Ensure that the disassembled parts are free from seizure, interference and uneven contact.
 - 2) Measure and record wear condition of parts and clearance.
 - 3) If the problem is found in a part, repair or replace it with a new one.
- (4) Reassembling hydraulic equipment
- 1) Turn ON the ventilation fan or open windows to maintain good ventilation prior to starting the cleaning of parts.
 - 2) Perform rough and finish cleaning before assembling.
 - 3) Remove washing oil by air and apply clean hydraulic or gear oil for assembling.
 - 4) Always replace the removed O-rings, backup rings and oil seals with new ones by applying grease in advance.
 - 5) Remove dirt and moisture from and perform degreasing on the surface where liquid gasket to be applied.
 - 6) Remove rust preventive agent from the new parts before use.
 - 7) Fit bearings, bushings and oil seals using special jigs.
 - 8) Assemble the parts utilizing matching marks.
 - 9) Ensure all the parts are completely assembled after the work.
- (5) Installing hydraulic equipment
- 1) Ensure hydraulic oil and lubricant are properly supplied.
 - 2) Perform air releasing when:
 - a. Hydraulic oil changed
 - b. Parts of suction side piping replaced
 - c. Hydraulic pump installed
 - d. Slewing motor installed
 - e. Travel motor installed
 - f. Hydraulic cylinder installed
- !** Operation of the hydraulic equipment without filling hydraulic oil or lubricant or without performing air releasing will result in damage to the equipment.
- 3) Perform air releasing after loosening the upper drain plug, starting the engine and keep it in low

idle condition. Complete the air releasing when seeping of hydraulic oil is recognized, and tightly plug.

- 4) Perform air releasing of the travel motor and the hydraulic cylinders by running the engine for more than 5 minutes at low speed without load.

! Do not allow the hydraulic cylinder to bottom on the stroke end just after the maintenance.

- 5) Perform air releasing of pilot line by performing a series of digging, slewing and travel.
- 6) Check hydraulic oil level after placing the attachment to the oil check position, and replenish oil if necessary.

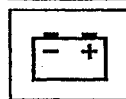
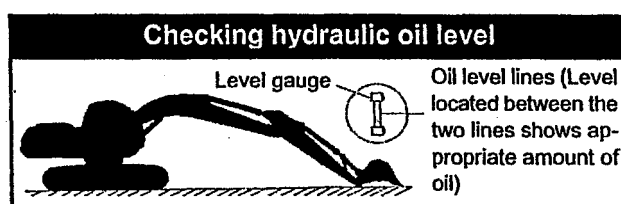

1.4 ELECTRICAL EQUIPMENT

- (1) Do not disassemble electrical equipment.
- (2) Handle it carefully not to drop and give a shock.
- (3) Turn the key OFF prior to connecting and disconnecting work.
- (4) Disconnect the connector by holding it and pressing the lock. Do not pull the wire to apply force to the caulking portion.
- (5) Connect the connector and ensure it is completely locked.
- (6) Turn the key OFF prior to touching the terminal of starter or generator.
- (7) Remove the ground (earth) terminal of battery when handling tools around the battery or its relay.
- (8) Do not splash water on the electrical equipment and connectors during machine washing.
- (9) Check for moisture adhesion inside the waterproof connector after pulling it out, since it is hard to remove moisture from the connector. If moisture adhesion is found, dry it completely before the connection.

- ⚠** • Battery electrolyte is hazardous.
Battery electrolyte is dilute sulfuric acid. Exposure of skin or eyes to this liquid will cause burning or loss of eyesight. If the exposure occurs, take the following emergency measures and seek the advice of a medical specialist.

- When skin exposed: Wash with water and soap sufficiently.
- When eyes exposed: Immediately wash away with city water continuously for more than 10 minutes.
- When a large amount of the liquid flows out: Neutralize with sodium bicarbonate or wash away with city water.
- When swallowed: Drink a large amount of milk or water.
- When clothes exposed: Immediately undress and wash.



1.5 HYDRAULIC PARTS

- 1) O-ring
 - Ensure O-rings have elasticity and are not damaged before use.
 - Use the appropriate O-rings. O-rings are made of various kinds of materials having different hardness to apply to a variety of parts, such as the part for moving or fixed portion, subjected to high pressure, and exposed to corrosive fluid, even if the size is same.
 - Fit the O-rings without distortion and bend.
 - Always handle floating seals as a pair.
- 2) Flexible hose (F hose)
 - Use the appropriate parts. Different parts are used depending on the working pressure even the size of fitting and the total length of the hose is same.
 - Tighten the fitting at the specified torque. Ensure no kink, tension, interference nor oil leakage is recognized.

1.6 WELDING REPAIR

- (1) Refer repair welding to qualified personnel according to the appropriate procedure.
- (2) Disconnect the ground (earth) cable of the battery before starting the repair. Failure to do so will cause damage to the electrical equipment.
- (3) Move away the articles in advance that may cause fire if exposed to sparks.

- (4) Before starting the repair of the attachment, do not fail to cover the plated surface of the piston rod with flameproof sheet to prevent it from being exposed to sparks.

1.7 ENVIRONMENTAL MEASURE

- (1) Run the engine at the place that is sufficiently ventilated.
- (2) Industrial waste disposal
Dispose of the following parts according to the relevant regulations:
Waste oil and waste container
Battery
- (3) Precautions for handling hydraulic oil
Exposure of eyes to hydraulic oil will cause inflammation. Wear protective glasses before handling to avoid an accident. If an eye is exposed to the oil, take the following emergency measures:
 - When an eye exposed: Immediately wash away with city water sufficiently till stimulative feeling vanishes.
 - When swallowed: Do not let vomit, and receive medical treatment immediately.
 - When skin exposed: Wash with water and soap sufficiently.
- (4) Others
Use replacement parts and lubricants

2. ESCAPING PROCEDURE IN CASE OF EMERGENCY

2.1 WHEN CAB DOOR DOES NOT OPEN ;(CAB spec. only)

- (1) Escape from the front window.
- (2) Escape from skylight.
- (3) When front window and skylight do not open ;
The life hammer is always reserved on the rear left side of cab. Break the glass on the rear side of cab, and escape from there.

- Break the window glass with care to protect eyes, and don't fail to break the window on which label "Emergency exit" is stuck.

- (4) In addition, the life hammer is equipped with a cutter on the lever side to cut the seat belt, etc.

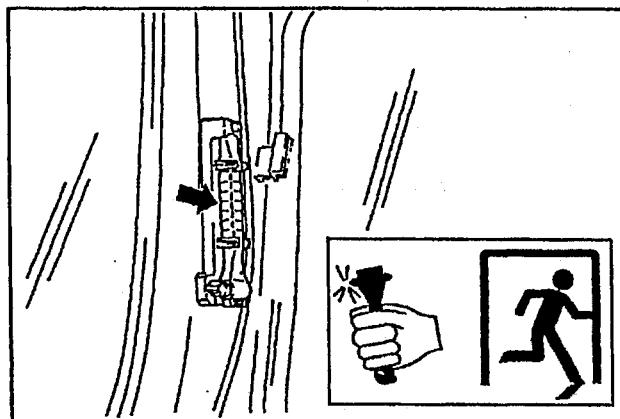

FIG. 2-1 LIFE HAMMER AND "EMERGENCY EXIT" LABEL

2.2 WHEN MACHINE CAN NOT GO OUT FROM THE SOFT GROUND BY ITSELF ;

1. If the machine should become stuck in soft soil areas it may be necessary to tow the machine. Attach a wire rope or chain, with the capacity to pull the machine out, to the lower frame towing eyes.
2. Attach other end to the vehicle used to pull the machine. Operate the Machine's Travel Lever in the proper direction while pulling with the other vehicle.

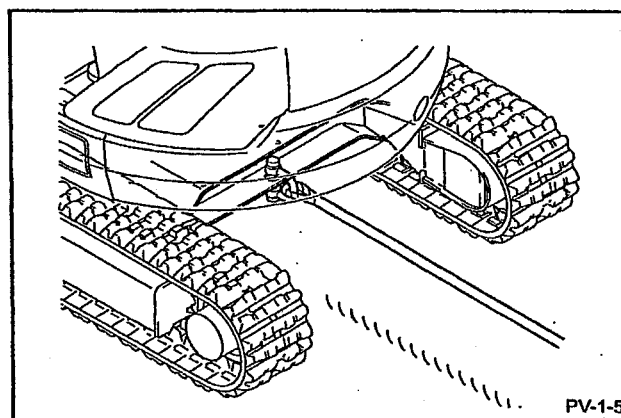



FIG. 2-2 TOW MACHINE PROPERLY

 WARNING 
<ul style="list-style-type: none">• While towing, do not enter between the machine and towing vehicle.• Do not apply a shock load onto the towing rope.• Make sure to always use towing eyes (shackles) or the towing.• Keep the wire rope horizontally, and perpendicularly to the crawler frame.• Tow the machine slowly at low speed mode.• For the towing of the machine body, provide pads to be applied to the corner of crawler frame to prevent the wire rope and crawler frame from any damages.

BUY NOW

**Then Instant Download
the Complete Manual
Thank you very much!**